

Final Report

# Hydraulic Performance Assessment of Pervious Concrete Pavements for Stormwater Management Credit

A Joint Research Program of

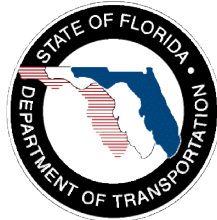

**Rinker**  
MATERIALS™

Submitted by

Marty Wanielista  
Manoj Chopra  
Josh Spence  
Craig Ballock

Stormwater Management Academy  
University of Central Florida  
Orlando, FL 32816

Editorial Review by: Ryan Browne

A handwritten signature in black ink, reading "Ryan J. Browne".

January 2007

4. Title and Subtitle <b>Hydraulic Performance Assessment of Pervious Concrete Pavements for Stormwater Management Credit</b>		5. Report Date <b>January, 2007</b>	
		6. Performing Organization Code	
7. Author(s) <b>Marty Wanielista, Manoj Chopra, Josh Spence, Craig Ballock</b>		8. Performing Organization Report No.	
9. Performing Organization Name and Address <b>Stormwater Management Academy University of Central Florida Orlando, FL 32816</b>		10. Work Unit No. (TRAIS)	
		11. Contract or Grant No.	
12. Sponsoring Agency Name and Address <b>Florida Department of Transportation 605 Suwannee Street, MS 30 Tallahassee, FL 32399</b>		13. Type of Report and Period Covered <b>Final Report (one of three on pervious concrete research)</b>	
		14. Sponsoring Agency Code	
15. Supplementary Notes			
16. Abstract <p>Portland cement pervious concrete's ability to infiltrate water has encouraged its use for stormwater management. However, the material has suffered historically poor acceptance due to a lack of data related to long term infiltration rates and rainfall retention which leads to an undefined credit for stormwater management.</p> <p>Before stormwater management credit could be estimated, it was necessary to develop a testing device to gather information from existing pervious concrete parking lots currently in use. Eight parking lots were examined to determine the infiltration rates of the pervious concrete, as well as to assess the soil makeup beneath pavement. A total of 30 pavement cores were extracted and evaluated for infiltration rates. Three of the sites had a pervious concrete section that included a gravel reservoir. Infiltration rates were measured using the application of an embedded single-ring infiltrometer.</p> <p>A mass balance model to simulate the hydrologic and hydraulic function of pervious concrete sections was developed. The purpose of the model is to predict runoff and recharge volumes for different rainfall conditions and hydraulic properties of the concrete and the soil.</p> <p>The field derived hydraulic data were used to simulate infiltration volumes and rainfall excess given a year of rainfall as used in a mass balance operated within a spreadsheet. The results can be used for assessing stormwater management credit.</p>			
17. Key Word <b>Pervious concrete, infiltration, model, site data, performance, infiltrometer, laboratory rates.</b>		18. Distribution Statement	
19. Security Classif. (of this report) <b>Unclassified</b>	20. Security Classif. (of this page) <b>Unclassified</b>	21. No. of Pages <b>73</b>	22. Price

## **Executive Summary**

The infiltration potential of Portland cement pervious concrete has encouraged its use as a stormwater management tool. However, the material has suffered historically poor support due to a number of factors, including failures due to poor mix design and improper construction techniques, concern about lesser structural strength, concern about poor long term performance due to clogging of surface pores and undefined credit for stormwater management. This study focuses on long term infiltration performances of pervious concrete parking lots and their stormwater management credit.

Before stormwater management credit could be estimated, it was necessary to develop a testing device to gather information from existing pervious concrete parking lots currently in use. Eight parking lots were examined to determine the infiltration rates of the pervious concrete, as well as to verify the soil infiltration rates beneath pavement. A total of 30 concrete cores were extracted and evaluated for infiltration rates. Three of the sites had a pervious concrete section that included a gravel reservoir. Infiltration rates were measured at the field sites using the application of an embedded single-ring infiltrometer. The water head for testing the infiltration rates must be set at the head that is expected in operation. For comparative purposes, filed infiltration testing was performed using a 3 inch head and compared to a water head at grade to 1 inch above grade. Laboratory infiltration tests were conducted at the standard 9 inch head.

Recommended for infiltration measurements for pavement that accepts no off site discharge is a minimum head as measured on the pervious concrete equal to the grade or within one inch of the grade. Higher heads produce higher rates of infiltration rate estimates.

To provide an estimate of stormwater credit, the authors of this study created a mass balance model to be used for simulation of the hydrologic and hydraulic function of pervious concrete sections over a one year period of time. The purpose of the model is to predict runoff and recharge volumes for different rainfall conditions and hydraulic properties of the concrete and the soil.

The field derived hydraulic data were used to simulate infiltration volumes and rainfall excess given a year of rainfall as used in a mass balance operated within a spreadsheet. The results can be used for assessing stormwater management credit using average annual efficiencies.

### **Disclaimer**

The opinions, findings, and conclusions expressed in this publication are those of the authors and not necessarily those of the State of Florida Department of Transportation.

## **ACKNOWLEDGEMENTS**

First and foremost, the authors would like to thank the Ready Mixed Research Concrete Foundation, Rinker Materials and the Florida Department of Transportation for their monetary support and technical assistance. Without their support, this research would not be possible. In addition, the support of the Florida Department of Environmental Protection and the owners of the pervious parking areas noted in this report are appreciated. Lastly, the Stormwater Management Academy located at the University of Central Florida provided valuable assistance in the collection and analyses of laboratory and field derived data.

The authors also thank the reviewers of the draft document. They were Eric Livingston of the State Department of Environmental Protection, Scott Hagen of the University of Central Florida, Michael Davy and Matt Offenbergl of Rinker Materials, and Karthik Obla of the National Ready Mixed Research Foundation.

# TABLE OF CONTENTS

<b>EXECUTIVE SUMMARY</b> .....	<b>III</b>
<b><u>ACKNOWLEDGEMENTS</u></b> .....	<b>V</b>
<b><u>LIST OF TABLES</u></b> .....	<b>VII</b>
<b><u>LIST OF FIGURES</u></b> .....	<b>VII</b>
<b><u>CHAPTER 1 – INTRODUCTION</u></b> .....	<b>1</b>
<u>1.1 OBJECTIVES</u> .....	2
<u>1.2 LIMITATIONS</u> .....	2
<u>1.3 APPROACH</u> .....	3
<b><u>CHAPTER 2 - BACKGROUND</u></b> .....	<b>4</b>
<b><u>CHAPTER 3 – APPROACH TO PROBLEM</u></b> .....	<b>9</b>
<u>3.1 LAB EXPERIMENTATION</u> .....	9
<u>3.2 FIELD TESTING</u> .....	14
<b><u>CHAPTER 4 – MODEL</u></b> .....	<b>18</b>
<u>4.1 PRECIPITATION</u> .....	19
<u>4.2 MASS BALANCE PARAMETERS</u> .....	23
<b><u>CHAPTER 5 – RESULTS AND DISCUSSION</u></b> .....	<b>25</b>
<u>5.1 FIELD TESTING</u> .....	25
<u>5.2 MASS BALANCE</u> .....	30
<u>5.2.1 Simulation</u> .....	30
<u>5.2.2 Yearly Retention</u> .....	<i>Error! Bookmark not defined.</i>
<u>6.1 FUTURE RESEARCH</u> .....	36
<u>6.1.1 Recommendations for Testing</u> .....	36
<u>6.1.2 Recommendations for the Mass Balance</u> .....	37
<b><u>APPENDICES: DATA</u></b> .....	<b>39</b>
<b><u>LIST OF REFERENCES</u></b> .....	<b>70</b>

## LIST OF TABLES

<a href="#">Table 1 - Field Sites</a> .....	25
<a href="#">Table 2 - Core Pervious Concrete Infiltration Rate Data</a> .....	27
<a href="#">Table 3 - Soils Infiltration Data</a> .....	29
<a href="#">Table 4 - Laboratory Concrete Compared to Field Concrete and Soil Infiltration Rates</a> .....	29
<a href="#">Table 5 - Mass Balance Results</a> .....	32

## LIST OF FIGURES

<a href="#">Figure 1 - Double Ring Test on Pervious Concrete</a> .....	10
<a href="#">Figure 2 - One Dimensional Flow at Soil-Concrete Interface</a> .....	11
<a href="#">Figure 3 - Single-Ring Infiltrometer</a> .....	12
<a href="#">Figure 4 - Laboratory Core Test</a> .....	17
<a href="#">Figure 5 – Mass Balance Logic Diagram</a> .....	21
<a href="#">Figure 6 - Sample Rainfall Data Amendment</a> .....	22
<a href="#">Figure 7 – Model Cross Section</a> .....	24
<a href="#">Figure 8 – <math>F_{aq}</math> Sensitivity for Yearly Volume Retention</a> .....	31
<a href="#">Figure 9 - Percent Yearly Volume Retention as a Function of Concrete Infiltration Rate</a> .....	33

## **CHAPTER 1 – INTRODUCTION**

Stormwater management methods seek to decrease the negative effects of land use changes by reducing and attenuating surface runoff and by promoting infiltration. Pervious concrete is a type of porous pavement that can be used as an infiltration practice for stormwater management. It has an open-graded structure and consists of carefully controlled portions of small stone aggregate, cement, water, and admixtures. The open-graded structure of the concrete promotes rapid passage of water and allows it to infiltrate underlying soils. Pervious concrete, already recognized as a best management practice by the Environmental Protection Agency (USEPA, 1999), has the potential to become a popular alternative for dealing with stormwater runoff.

However, a lack of data, particularly with respect to the long-term performance, leads to hesitation in using pervious concrete as an acceptable stormwater management practice alternative. The author of this study established a continuous, mass balance flow model that will predict the hydrologic function of a pervious concrete system for a year long rainfall simulation. This model was designed for application in areas such as pervious concrete parking lots and low-volume roadways. An important part of this research involved determining a method for measuring the infiltration rates through pervious concrete sections. Testing included field investigation of pervious concrete parking lot sites and laboratory infiltration tests on sample cores gathered during field investigation. A total of eight pervious concrete parking areas, all of which have been operational for at least several years, were investigated during the course of the study.



## **1.1 Objectives**

The objectives of this research are threefold:

- 1) Develop an on-site testing method for measuring infiltration rates of pervious concrete parking lots. The purpose was to measure hydraulic operational efficiency and to gather data for utilization in modeling and simulations of infiltration rates.
- 2) Develop a mass balance spreadsheet to catalogue the flow through a pervious concrete and soil section and that which remains on the surface given hourly rainfall data.
- 3) Utilize the results from the mass balance spreadsheet to predict operation efficiency in terms of surface runoff and groundwater recharge for various combinations of water table depth, soil porosity/permeability, concrete porosity/permeability, and concrete depth.

## **1.2 Limitations**

The results are constrained by several limitations. Most of the field recorded data originated from sites within the southeastern United States (five of the eight sites visited were in Florida). A testing infiltrometer was developed for existing pavements, but could not be embedded into gravel sub-base. The method did function with sandy sub soils. Thus the method could not predict systems with gravel reservoir layers. The mass balance uses three main simplifying assumptions: (1) that the soil is homogenous and isotropic to the depth of the water table, (2) flow is one dimensional, and (3) rainfall excess occurs and is removed immediately as infiltration or runoff. The credit was assumed to be based on an average annual percent of rainfall that infiltrates into the concrete and the soils.

### **1.3 Approach**

This document consists of six chapters. Provided in this first chapter is an introduction to the topic and also a description of the research objectives. In chapter two, a review of the current state of pervious concrete and existing research on the topic is presented. The theoretical approach to the problem is covered in chapter three, including development and discussion of the aspects of the mass balance and the input data. Chapter four lists the processes for data collection. Results of the field and laboratory testing are presented in Chapter five along with the results of the mass balance simulations. Chapter six concludes with a discussion, summary, recommendations and conclusions.

## **CHAPTER 2 - BACKGROUND**

Humans alter the natural environment as they construct buildings and roadways. One of the most notable changes is the addition of impervious area in places that were previously permeable surfaces. Impervious areas prevent water from infiltrating into the soil underneath. Examples of impervious area include rooftops, parking lots, and roadways.

The addition of impervious areas to a location negatively impacts the environment by altering the natural water cycle. These areas block the natural process of infiltration through the soil, and results in runoff from the impervious surfaces after storm events and snowmelts. This runoff results in three main problems: (1) a decrease in groundwater recharge due to lack of infiltration, (2) alteration in the natural flow patterns of a drainage basin, and (3) transportation of contaminants, deposited on impervious surfaces, to receiving water bodies (Brattebo and Booth, 2003). Thus, the introduction of impervious areas interrupts both surface and subsurface water quantity and quality.

From these problems others may arise. Changing natural flow patterns can cause erosion and flooding of naturally occurring channels unaccustomed to handling larger flows of water (Brattebo and Booth, 2003). Furthermore, contaminants including heavy metals (e.g. copper, lead and zinc), nutrients (e.g. phosphorous and nitrogen), and sediment material can travel in runoff water and be deposited in receiving water bodies. These materials severely alter and destroy aquatic habitats, which results in the death of organisms dependent upon that habitat.

Traditionally, runoff peak rates have been controlled and attenuated using storm sewer systems with detention or retention basins (Schluter and Jeffries, 2002). These systems collect the runoff primarily from impervious areas and store the water where it can either

infiltrate (retention basin) or be discharged at a controlled rate to a water body (detention basin). Design, operation, and maintenance of these basins are governed by regulations established by state, regional or local government agencies.

There is always an interest in finding new ways to manage stormwater runoff associated with new development or redevelopment. Porous pavements, an alternative method for stormwater control, represent an innovative method. Types of porous pavements include porous asphalt, pervious concrete, concrete paving blocks, gravel paving systems, and grass paving systems, among others. Pervious pavements reduce runoff volume by allowing water to pass through them and to be stored and subsequently be released into the ground. Most pervious pavements contain large numbers of pore spaces and allow water to pass through them at a rapid rate.

Pervious concrete is the focus of this research. It is a material that consists of open-graded coarse aggregate, Portland Cement, water and admixtures. Generally the aggregate is evenly graded to have a size of approximately 3/8 of an inch; sand is omitted from the process leaving the space in between coarse aggregate empty. Typical sections of pervious concrete have 15 percent to 25 percent void space; some sections may have values as high as 35 percent (Brown, 2003). Most void spaces are interconnected which allows water and air to pass through the section. Newly placed pervious concrete sections have been reported to drain at rates ranging from two to 18 gallons per minute per square foot (Brown, 2003).

Pervious concrete is known to have the advantages of reducing runoff volume and may improve water quality in ground water recharge (Legret et al, 1996). By allowing stormwater runoff to infiltrate, pervious concrete filters sediment and other contaminants that would otherwise make their way to waterways. Similarly, because water can infiltrate

through the concrete layer, pervious concrete parking lots and other installations can serve as recharge basins. Other known advantages of pervious concrete include better road safety because of increased skid resistance, road sound dampening, and dampening of the “heat island” effect (Yang and Jian, 2003), (USEPA, 1999), (Brown, 2003).

Pervious concrete also has several potential disadvantages. Those of most concern include perceived cold weather problems, the potential of clogged void spaces, historical high construction failure rates, and the potential to contaminate ground water (EPA, 1999). High construction failure rates are often associated with poor design and contractors who lack sufficient knowledge for proper installation of the product. The two issues or problems frequently expressed to be of greatest concern are the potential of clogged void spaces and credit as a stormwater management practice within stormwater regulations. This research provides data for both issues. However, groundwater contamination is not addressed.

Pervious concrete has begun to receive greater attention as a viable stormwater management practice. The American Concrete Institute has established a committee (ACI Committee 522, 2006) to determine guidelines for the proper use of pervious concrete. To enhance this document, the committee needs data on the long-term performance of pervious concrete systems. Data are needed on design characteristics, durability, maintenance plans, and effective infiltration rates after years of service.

This information would also be valuable to water management districts in an effort to provide a standard for use of pervious concrete in stormwater runoff control. In Florida, stormwater management criteria are largely developed and implemented by the Department of Environmental Protection (DEP) and the regional water management districts. Currently, only the DEP provides credit for pervious concrete as a stormwater management practice.

None of the State of Florida regional water management districts currently provide credit as a stormwater treatment or flood control practice. However, there is provision and national standards that are used on a site-by-site basis using design guidelines to apply for credit (Training Manual, 1998, NRMC, 2004, and FCPA in Pervious Pavement Manual, 2006). It is anticipated that the data of this report will facilitate the application for credit.

There are some tradeoffs between pervious concrete, the most notable of which is cost. The initial cost of pervious concrete can be up to 1.5 times that of other conventional paving methods. This excess of cost is a function of two things. First, pervious concrete is a specialty product requiring experienced skilled labor to install the concrete properly. This specific experience requirement accompanied with low demand drives the price up. Secondly, there is also an extra depth associated with pervious concrete. The extra depth is a function of a couple of factors including a need for extra rainfall storage within the concrete layer and an increased necessary depth for strength reasons.

Typical concrete is around 4000 psi or greater where pervious concrete is commonly around 2,000 psi (Ferguson, 2005). A lower compressive strength requires an additional thickness of pavement to help distribute vehicular loading. Normal depths for concrete paving are about four inches and a normal depth for a pervious concrete paving is six or more inches.

Though there is an expected increase of cost for pervious concrete, that cost can potentially be recouped by the increase in developable area that comes with a decrease in the area required for stormwater management. Other benefits include better traction during wet whether due to free draining pavement, reduction in road noise due to dampening effects in

the concrete, glare reduction at night, and better growth environment for adjacent landscaping (Ferguson, 2005), (ACI, 2006).

Pervious concrete has been in existence in the United States for nearly 50 years (Brown, 2003). Though not a widely used product, pervious concrete has been proven effective as a porous pavement in applications such as parking lots, low-volume roadways, and pedestrian walkways. It is necessary to develop standard design, manufacturing, and installation methodology that will establish pervious concrete as a reliable product capable of performing adequately for these uses. Currently there are no regulations or standard design criteria for this technology, thus it is not validated as a presumptive stormwater management method. Pervious concrete has the potential to reduce the amount of, or eliminate the area set aside for stormwater management practices, thus maximizing the amount of land available for development. If a compilation of data shows an agreeable evaluation of long-term performance, this material may become more widely accepted for its beneficial properties. Such information could be used to develop statewide design, construction, inspection, and maintenance requirements within stormwater regulations.

## CHAPTER 3 – APPROACH TO PROBLEM

### 3.1 Lab Experimentation

Prior to creation of a flow model sequence, it was necessary to develop a testing method to assess the conditions of pervious concrete paved areas and apply that method at the selected field sites. Data collected from field testing was applied in the model and was also used to assess the efficiency of pervious concrete as a stormwater management practice after it had been in operation for several years.

The first step was to create a field lab for experimentation at the University of Central Florida. A site was chosen at the Stormwater Management Academy's Laboratory and plans were created for the test cells. The test cells were designed as a self-contained box that was impermeable on all sides except for the surface. There were two "boxes" each six feet square and four-and-one-half feet deep from the surface of the pavement. The design included an underdrain system for the removal of water. The boxes were constructed side-by-side into the face of an existing berm.

Fill material for these cells consisted of a clean, brown, fine sand common to the University of Central Florida area. The soil had a hydraulic conductivity of approximately 12 inches per hour as determined by permeability testing and corresponded to NRCS hydrologic group A. Fill was compacted inside the boxes in eight-inch lifts to approximately 92 percent of the maximum dry density as determined by a standard proctor test. After compaction, the infiltration rate was approximately two inches per hour as determined by application of a double-ring infiltrometers test (ASTM D 3385-94).

The test cells were used to conduct double-ring and single-ring infiltration studies. In one cell a six inch deep reservoir of poorly graded stone was used, while the other had no



stone. The cells could not be used for mass balance experimentation because of leakage but the cells were used for developing infiltration measurements.

Initial testing was done using a standard double-ring infiltrometer (ASTM D3385-94) on the surface of the concrete similar to the procedure used by Bean and others in 2004. It quickly became apparent that this was an ineffective approach for pervious concrete because of the drastic difference in permeability between the concrete and the underlying soil (initial testing was done on newly poured concrete). Once the infiltrating water moved through the pervious concrete zone and reached the interface between the concrete and the soil it began to move laterally – See Figure 1. This grossly exaggerated the infiltration rate for the pervious system because it did not take into account the fact that water simply filled up the free pore space adjacent to the double ring infiltrometer and water was not infiltrating into the subsoil nearly as quickly as it appeared to be using the double ring.

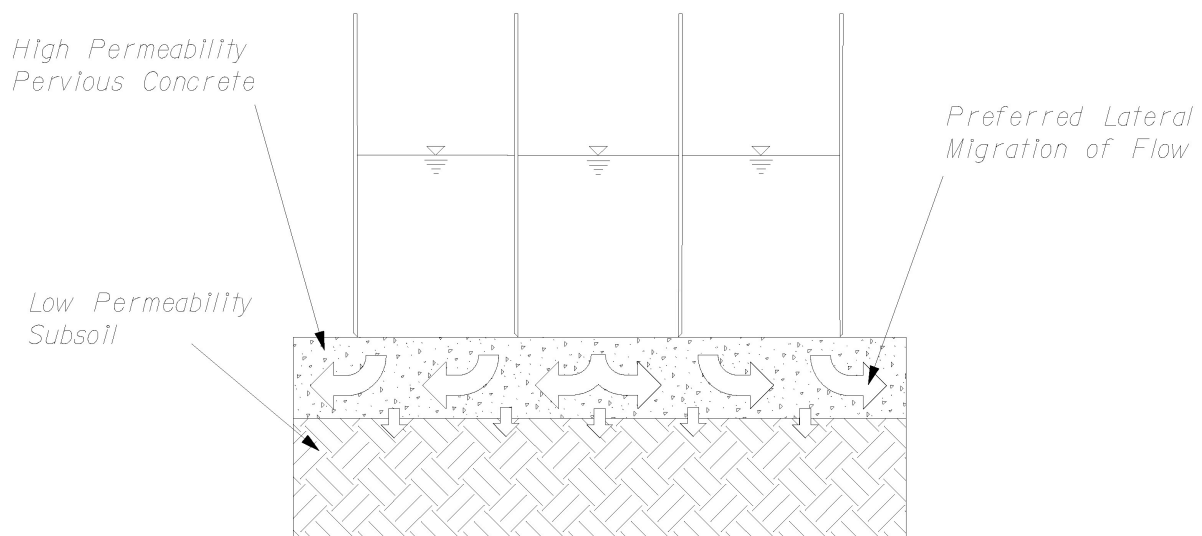

Figure 1 - Double Ring Test on Pervious Concrete

After several of these tests with double-rings on the surface of the concrete, it was decided that it was necessary to treat the pervious concrete – soil interface as a “system”. It was only when the two layers were isolated and one-dimensional flow encouraged, that a more realistic measurement of performance was obtained. See Figure 2.

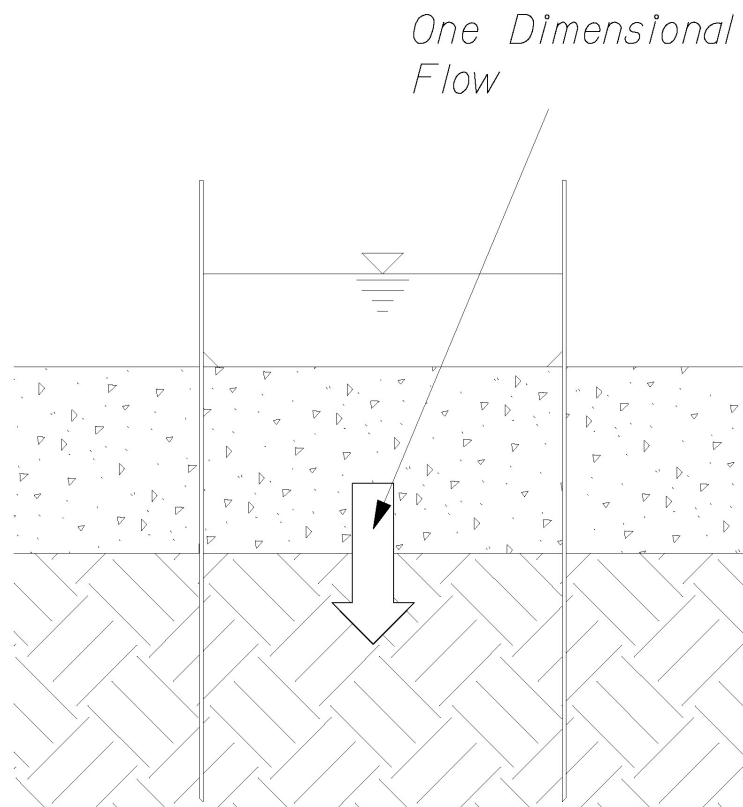

Figure 2 - One Dimensional Flow at Soil-Concrete Interface

It was decided that the best way to approach this was to remove a circular section of concrete using a concrete coring machine. A 12-inch diameter bit was decided upon because it was large enough to provide a “representative area” and small enough to be easily

handled. A 12-inch bit creates an 11 5/8-inch diameter core with a 3/16-inch space around the outside (image). A special order was placed with a steel design company to create a 20-inch long rolled steel tube with an inner diameter of 11 5/8 inches and 10-gauge thickness. The tube was designed to be inserted around the concrete core and embedded into the underlying soil – a single-ring infiltrometer which encourages one-dimensional flow through the interface of the pervious concrete and the soil. Figure 3 shows the dimensions and function of a single-ring infiltrometer.

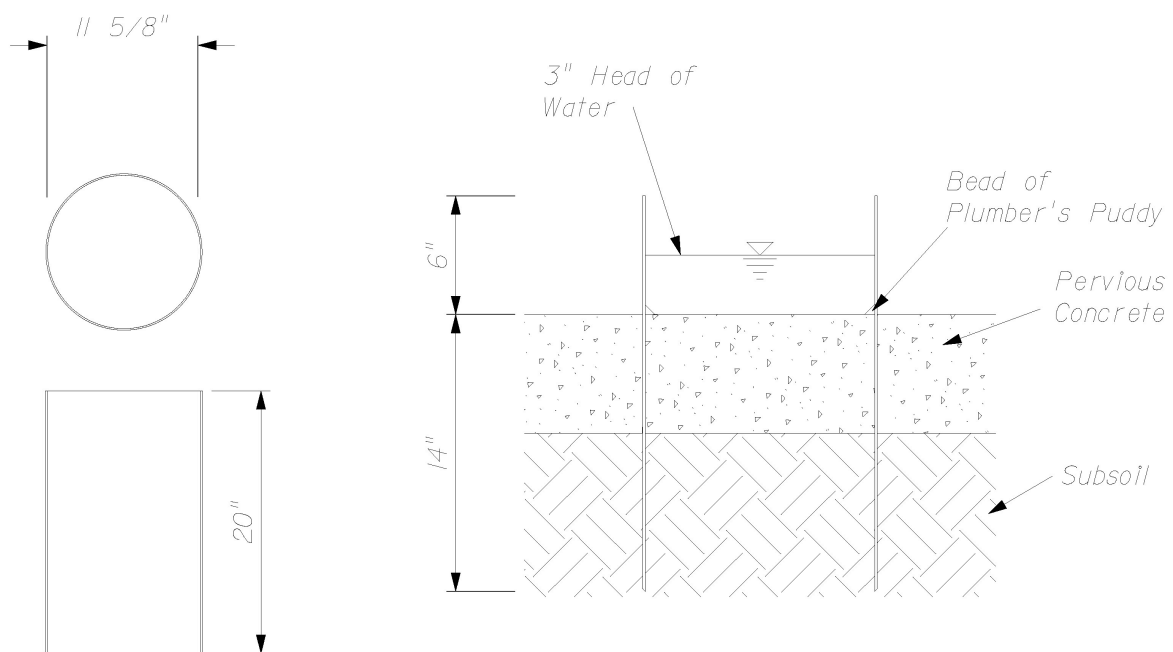

Figure 3 - Single-Ring Infiltrator

The testing procedure for the single-ring infiltrometer was much like that for the double-ring test – a specific head (three inches) was maintained, water was added at

specified time intervals, and the amount of water added at each time interval was recorded. The tests were stopped after at least two consecutive time periods after which approximately equal additions of water were added, provided that at least one inch of water over the area was added. One inch is equivalent to the 90% occurrence storm.

The head maintained for infiltration tests was found to be important as the greater the head (up to 9 inches), the higher the infiltration rate relative to a head maintained near the grade (top) of the pervious concrete. From repeated tests on the same section of pervious concrete, the infiltration rate using the embedded single ring varied from a low of about 2.5 inches per hour at a head measured at grade to 1 inch, to a maximum rate of about 7 inches per hour at a head of 9 inches. At the experimental head of 3 inches, the average limiting rate was about 3.8 inches per hour. This rate will also vary among the various field sites.

Embedment depth was determined by a several factors – the necessary depth to maintain one-dimensional flow at the concrete soil interface and sufficient length of tube to store at least the water equivalent to mean annual one day storm volume in Florida. At least three inches of pipe above the pavement was maintained to allow for a specific head and to allow for removal of the tube after embedment. The final design called for 14 inches (beneath the surface of the concrete) and 6 inches of concrete to store at least 4 inches of rainfall at porosities of 0.20 for the concrete and 0.35 for the soil. The mean rainfall depth of the maximum yearly one day storm volume in Florida is about 3.5 inches (Wanielista, et. al. 1991).

Multiple single-ring infiltrometer trial tests were conducted on the test plot. Results from these trials showed approximately two inches of water were added during the course of each testing run, thus exceeding the one inch 90% occurrence storm event. Also, at this rate,

and considering the porosity of the soil (assumed 0.35), the wetting front of the infiltrated water would not have passed the depth of the embedded tube during the course of the test. This gave reasonable assurance that 1-D flow was approximated at the soil-concrete interface. It was assumed that other sites visited would have similar soil characteristics and that this same embedment depth would be sufficient for those cases.

Removal of the embedment ring was a difficult task with which to deal. The ring was embedded using compaction force – once embedded, it was lodged so securely that it could not be removed by simply pulling up on the apparatus. To resolve this issue,  $\frac{1}{2}$ -inch holes were drilled in the steel, approximately one inch from the top of the tube. The holes were then threaded with a u-bolt attached to a chain; the chain was wrapped around a two foot long, two-inch by two-inch hollow-body steel section. The steel section was laid across two hydraulic jacks, which were then used to hoist the infiltrometer out of the ground.

### **3.2 Field Testing**

Upon arrival at a site, the first action was to walk the parking lot to identify potential coring sites. Locations to be cored were marked with a with a red construction crayon – a line was drawn bisecting where the core should go so that the core could be aligned appropriately after it was cut. If the site contained sections that were noticeably clogged in appearance, one core was extracted from such an area. The remaining two cores were removed in areas that appeared to be in fair operating condition.

The next step was to drill the cores into the concrete. The drilling process took between 10 and 30 minutes per hole depending on the type of aggregate used in the concrete mix and depth of the concrete slab. After the drilling was completed, the cores were removed from the holes. It was sometimes necessary to grind the sides of the cores to

smooth irregularities formed during the coring process and allow for easy passage of the infiltrometer over the core. A four-inch angle grinder with a masonry disk was utilized for this task.

After grinding the cores, two of the three are returned into their respective holes (four if this is conducted at a site with six cores). The infiltrometer was inserted around the core and was embedded into the subsoil by application of downward force. In the case of these field investigations, force was applied utilizing a hand-tamper. A two-foot long section of four-inch by four-inch lumber was placed across the top of the infiltrometer to distribute the load and protect the edges of the tube. It was important to mark the infiltrometer prior to embedment to ensure insertion to the appropriate depth (14 inches). After embedment, a bead of plumber's putty was placed around the edge of the core to prevent side-wall leakage, and the tests were conducted on the two cores using the methods described above. After completion of the infiltration tests, the infiltrometers were removed and one of the infiltrometers is inserted into the remaining hole without the core in place. The infiltration test was repeated on the subsoil, the depth of embedment remains 14 inches; however, the head used in this test is three inches in addition to the average depth of the concrete cores. This was done to provide comparison between the rates provided with the concrete in place and the rates of the soil alone.

After the final test, the infiltrometer was removed and all of the cores are taken for additional lab analysis. A soil sample was taken from the site using a hand auger. Samples were at intervals down to the water table or to a depth of six feet, whichever came first. If the water table were encountered, the water was allowed to normalize in the hole for 30

minutes, or until no noticeable water level change, and then the depth was measured from the bottom of the concrete.

Upon completion of testing at a site, the cores from that site were collected and labeled appropriately. Holes in the concrete created by the coring process were patched using Portland Cement pervious concrete. All Florida sampling was done during the rainy season (June-October) of 2005. The out-of-state sites were sampled during December 2005.

Upon return from the field, soil samples were sieved, categorized and selectively tested for permeability. The cores were individually tested for permeability. Permeability tests on cores were conducted by wrapping the cores tightly in six millimeter plastic and securing the plastic along the entire length of the core with duct tape. The wrapped core is elevated on wooden blocks and the infiltrometer is fitted over it. The gaps between the core and the infiltrometer are filled with plumber's putty. The infiltrometer is filled to a specific head of water and the setup is checked for leaks prior to the beginning of the test. After checking for leaks the test is continued, utilizing the same techniques as described above for the embedded test. See Figure 4 for laboratory test set up. The test protocol calls for a nine inch head, so comparisons to the field infiltration rate data are not valid. However, comparisons among the laboratory data are possible.

The field and laboratory results are show for each site in Appendix A. Graphs of the cumulative infiltration during field tests are also shown in Appendix A.

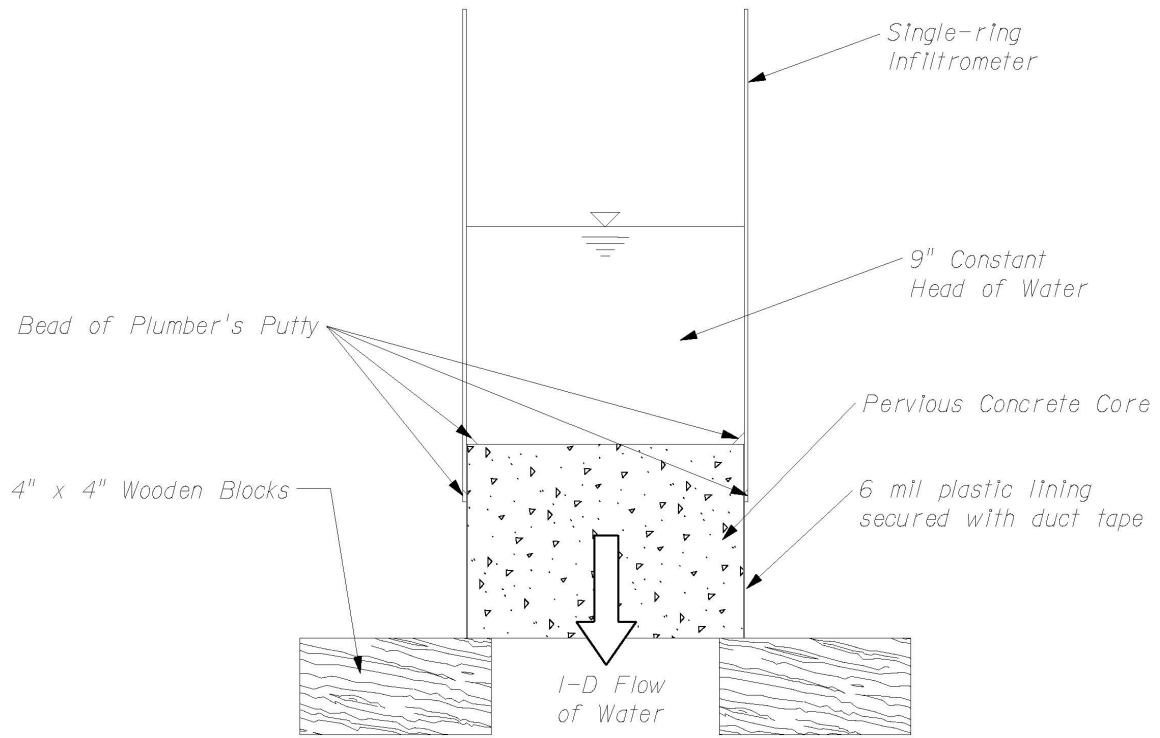

Figure 4 - Laboratory Core Test



## **CHAPTER 4 - MODEL**

Pervious concrete and the subsoil can be modeled using either event based or continuous simulations. The storage of rainfall within the concrete and soil matrix (system) is important because the storage and the amount of rainfall entering into the system along with the infiltration, porosity, and percolation from the system determine the amount of rainfall excess. Rainfall excess is defined as the volume of water that has not infiltrated within the time period of the model and thus is available for runoff. This is a conservative assumption for estimating runoff because some of the rainfall excess may infiltrate over time or pond on the pavement and evaporate before it reaches the discharge as runoff from the pavement.

If an event based model is used, assumptions on the pre storage conditions have to be made. If a continuous model is used, the pre event storage conditions will be determined from rainfall and water storage conditions of the soil and the pavement resulting from the previous rainfall. The continuous accounting for storage and rainfall excess can be described by a continuous time based model. Thus, given the amount of rainfall on a continuous basis, the storage and rainfall excess can be predicted. A Continuous Model such as VS2DH (USGS) was examined but the data requirements exceeded the data available from existing field observations. Thus a one-dimensional continuous simulation model was developed.

The model was designed as one-dimensional simulation of flow through a pervious pavement slab and subsoil. This simulation model used a mass balance approach to simulate the overall results of “average” annual rainfall data. The mass balance was constructed

using the spreadsheet program “Microsoft Excel”. Figure 5 presents a logic diagram that governs the approach and calculations used in the mass balance for the concrete and for the subsoil, respectively. Inputs for this simple model included time-stamped incremental rainfall data, three basic flow rates, concrete porosity and depth, and soil porosity and depth to the water table. Outputs are rainfall excess and recharge to the water table.

#### **4.1 Precipitation**

Rainfall data were collected and provided by Orange County Stormwater Division, and were measured at the Michael’s Dam gauging station near the University of Central Florida. The year of data selected was 2003 because during that year approximately 53.43 inches of rain occurred. The average annual rainfall for Central Florida is approximately 49.09 inches (City of Orlando Public Works). Thus, rainfall for 2003 was approximately an average year of rainfall. The same data based was used for comparison model regardless of where the filed sites were located. In the Tallahassee region, the average rainfall volume per year exceeds 64 inches. Whereas in the Georgia and South Carolina sites had rainfall volumes closure to that of central Florida.

As the data were collected by a tipping bucket, readings only existed for periods of time during which there was precipitation. Additionally, the tipping bucket recorded 0.01 inches of rain at times to the nearest minute. Thus, during heavy storms, multiple rainfall records could be tabulated for one minute, which becomes input to the continuous simulation model. As a result of this type of recordkeeping, the data input to the model was such that one minute time steps could be used when it was raining, and then other time steps could be used for non rainfall conditions.

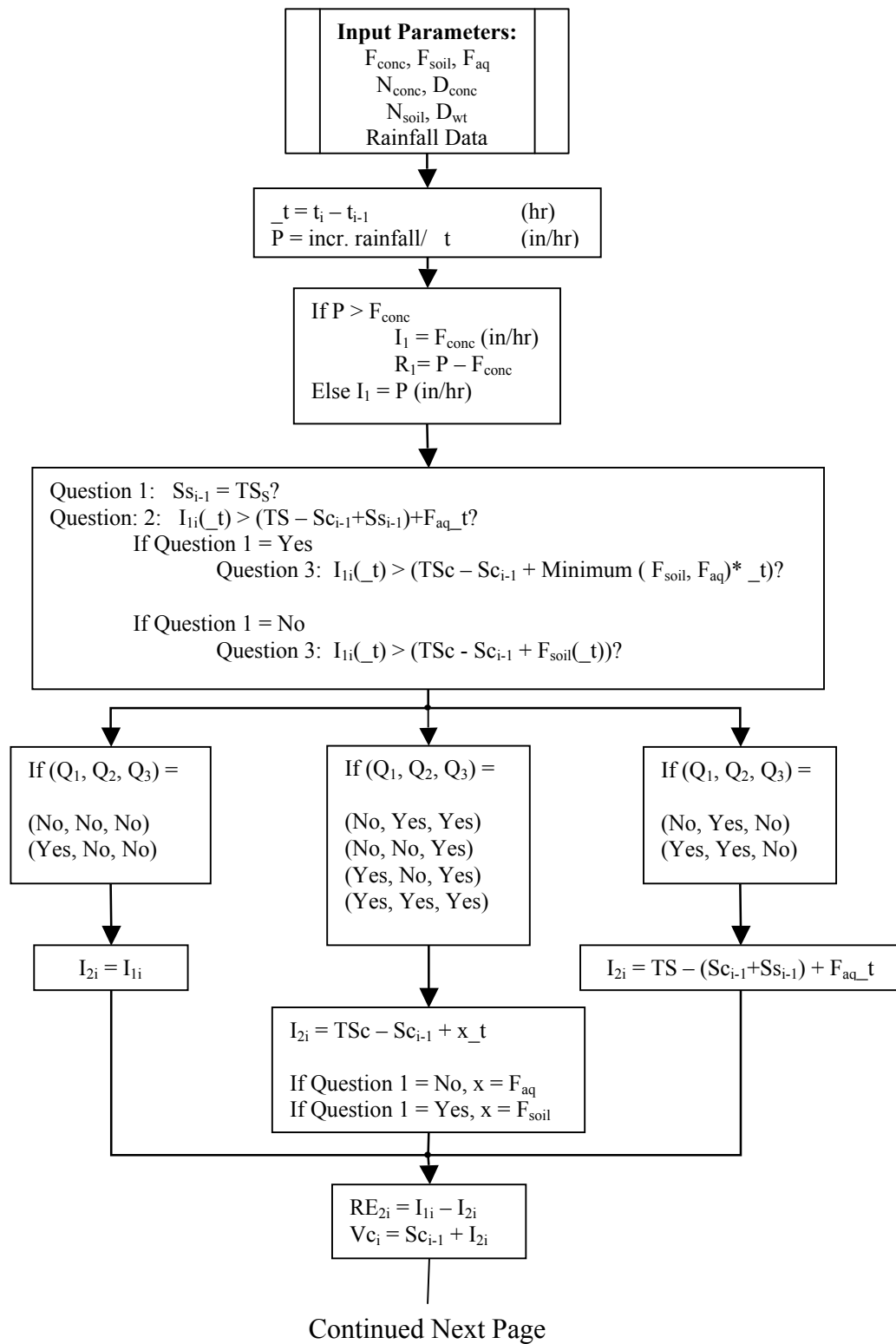
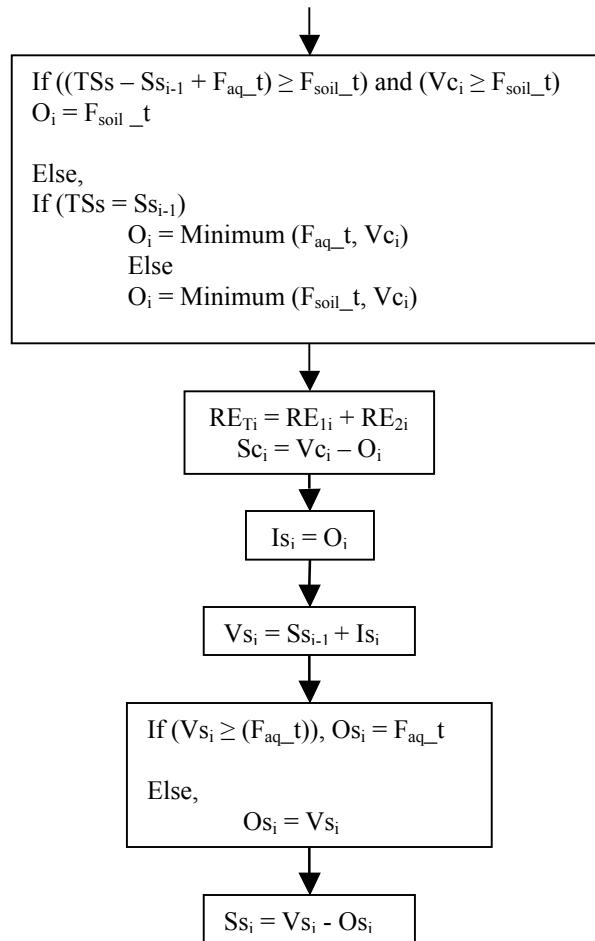

Figure 5. Mass Balance Logic Diagram



### Variable Definitions

P = incremental rainfall rate (in/hr)  
 I = incremental rate into concrete (in/hr)  
 RE = rainfall excess (in/hr)  
 O = incremental rate out of the concrete (in/hr)  
 Is = incremental rate into soil (in/hr)  
 Os = incremental rate out of soil  
 TS = total storage available in concrete and soil (in)  
 TSs = total storage in soil (in)  
 TSc = total storage in soil (in)  
 Ss = water stored in soil (in)  
 Sc = water stored in concrete (in)  
 Is = incremental rate into soil (in/hr)  
 Os = incremental rate out of soil  
 Vs =  $Ss_{i-1} + Is_i$  (in)  
 Vc =  $Sc_{i-1} + I_i$  (in)

### Input Parameters

$F_{conc}$  = Concrete Conductivity Rate (in/hr)  
 $F_{soil}$  = Soil Conductivity Rate (in/hr)  
 $F_{aq}$  = Aquifer Conductivity Rate (in/hr)  
 $D_{conc}$  = Depth of Concrete (in)  
 $D_{wt}$  = Depth to Water Table (in)  
 $N_{conc}$  = Concrete Porosity  
 $N_{soil}$  = Soil Porosity

Figure 5 – Mass Balance Logic Diagram (continued)

The rainfall data were sorted in such a way that if consecutive rainfall increment readings had a time stamp and values were more than one hour apart that they would be considered to belong to different rainfall events. The data were amended by inserting additional time stamps with zero incremental rainfall values into the precipitation data series such that the computational time step was less than or equal to one hour. The time step prior to the start of a storm event was placed at the nearest half hour prior to the time stamp of the first rain record for an event. Average incremental rainfall rates were calculated by dividing the current rainfall increment by the time difference between the current and previous recorded time. See Figure 6 for an example of how the rainfall data was amended.

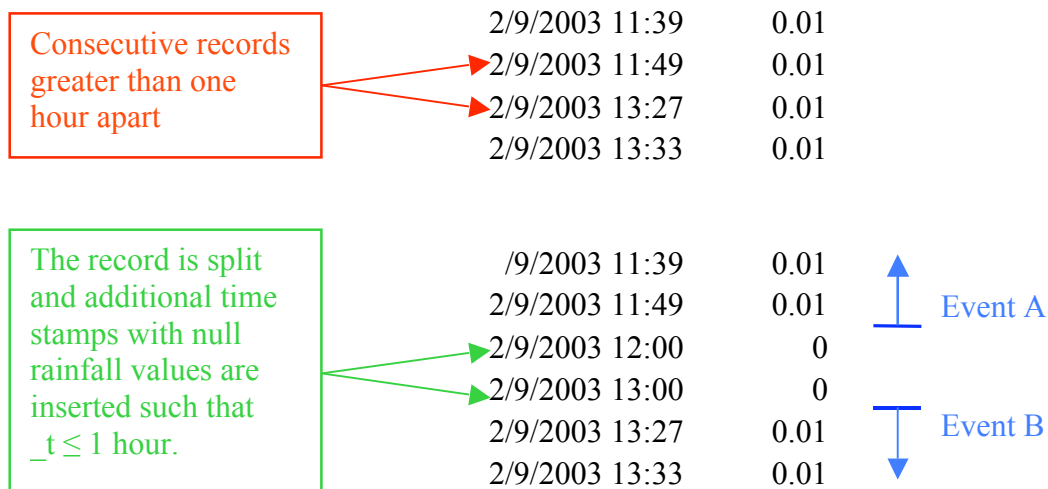

Figure 6 - Sample Rainfall Data Amendment

After the rainfall data were separated into individual rainfall events, rainfall events totaling less than 0.03 inches were deleted from the record used in the mass balance. These records were considered to be inconsequential and lost primarily to evaporation.

## 4.2 Mass Balance Parameters

The three basic flow parameters are defined as concrete flow rate, soil flow rate, and the rate at which the water moved away from the water table. Concrete and soil flow rates used in the simulations were gathered during the field and lab investigations. As stated previously, a number of cores were taken at each site; the value used for calculations in the mass balance model was an average value for each site. The soil rate used was determined by field tests as described previously. A cross section representation of the mass balance, as shown in Figure 2, illustrates the important parameters.

The assumed concrete porosity was taken to be 0.20. Pervious concrete has typical porosity values ranging from 0.18 to 0.35 (ACI 522R-06), thus 0.20 was used as a representative value. The depth of concrete used was the average for depth of the cores taken at a specific site.

All of the soils sampled during field testing were fine, sandy soils except for Site 4. A typical range of porosity for sandy soil is 0.25 – 0.55 (Charbeneau, 2000). A value of 0.35 for soil porosity was utilized in the mass balance modeling. Field measurement of the water table was only possible at two of the Central Florida sites. For the other two sites, water table depth was taken as the normal high water table depth as specified by NRCS soil survey maps for the respective areas. For Site 4, the clay layer was assumed to be at the bottom of the backfill sandy soil and the water table an additional 25 inches below the fill materials.

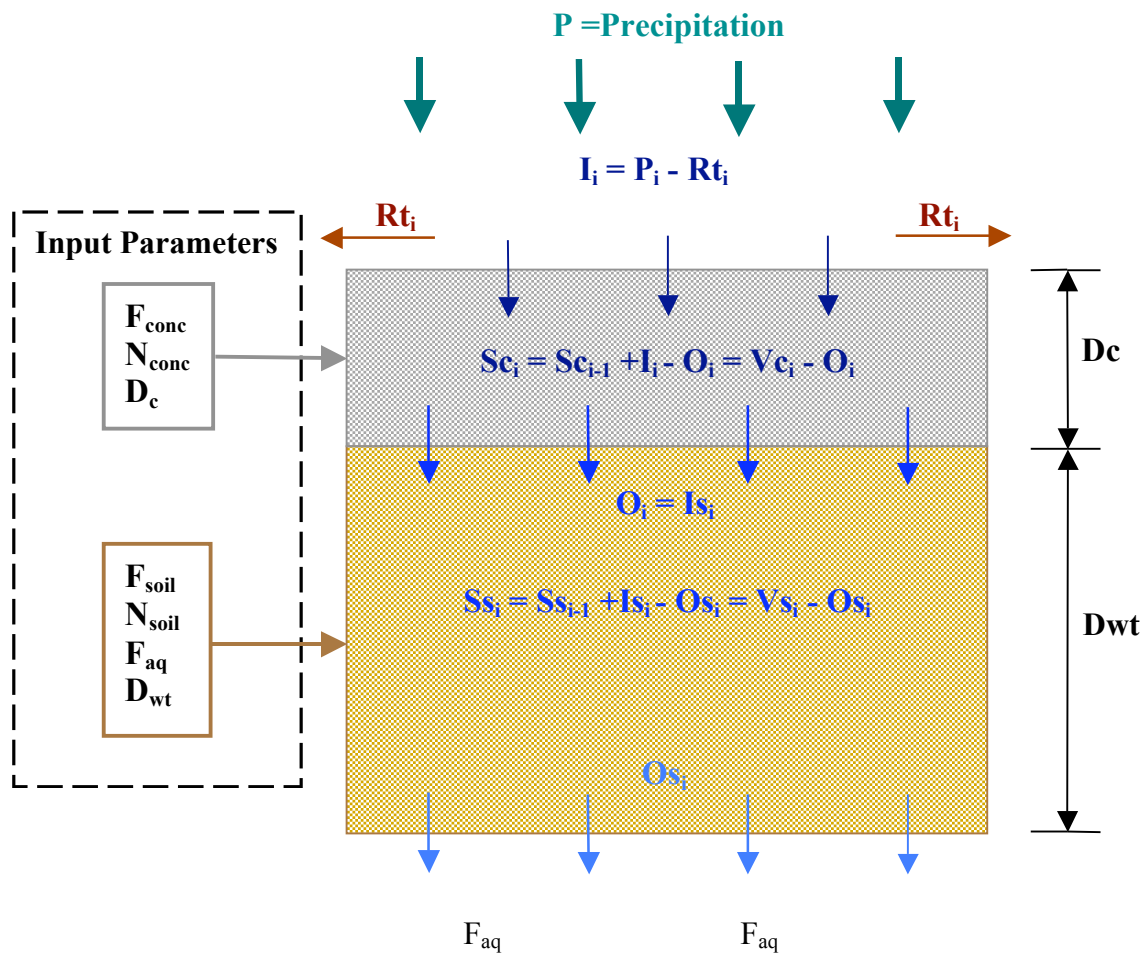

Figure 7 – Model Cross Section

## CHAPTER 5 – RESULTS AND DISCUSSION

### 5.1 Field Testing

The Florida sites were selected based upon proximity to the University, accessibility and age. A total of eight field sites were chosen for field investigation, four of which were located in the Central Florida area: Sunray Storaway, Strang Communication, Murphy Vet Clinic, and the Florida Concrete and Products Association (FCPA) Office. These sites range in age from six to 20 years with an average age of about 12 years.

The four other sites included locations in Tallahassee, Florida, Florida Department of Environmental Protection (FDEP) Office; Atlanta, Georgia, Southface Institute; Guyton, Georgia, Effingham County Landfill; and, finally, Greenville, South Carolina, Cleveland Park. See Table 1 for a summary of the sites visited and the order of visitation.

Table 1 - Field Sites in Florida, Georgia, and South Carolina

Site	Site Name	Description	Number of Cores	Age (years)
1	Sunray Storaway	Paved Areas at Storage Facility	6	14
2	Strang Communication	Paved Parking Area	3	13
3	Murphy Vet Clinic	Paved Parking Area	3	18
4	Florida Department of Env. Protection	Paved Loading Area	6	20
5	Florida Concrete & Products Assoc.	Paved Parking Area	3	6
6*	Southface Institute	Paved Parking Area/Driveway	3	10
7**	Cleveland Park	Paved Parking Area	3	10
8*	Effingham County Landfill	Paved Dumpster Pad	3	7

\* Sites in Georgia

\*\* Site in South Carolina



Depending on the size of the pervious area at the site, either three or six cores were extracted. A total of 30 cores were taken from all of the sites. The single-ring infiltrometer method was successfully used at only three of the five Florida sites tested – Sunray Storaway (four cores tested), Strang Communication (two cores tested), and the FDEP Office (four cores tested). Access to power was a limitation at the remaining two Florida sites.

The single-ring infiltration test at existing sites was not applicable for three of the sites that had gravel reservoirs with crushed granite. The reservoir prevented the insertion of the single-ring infiltrometer passed the depth of the concrete layer, thus the test could not be run.

Upon returning the cores to the University of Central Florida Stormwater Management Academy's Laboratory, all of the cores were individually tested for infiltration rate using the technique mentioned before as illustrated in Figure 4. Field and laboratory test rates are comparatively presented in Table 2. It is noted that the field site test also included infiltration through the sub-soils, which may have been the limiting rate. Though there is not sufficient field data for an accurate comparison, available field-obtained infiltration data does not correlate with data obtained through laboratory experimentation. Instances where the field rates are less than those obtained in the laboratory may perhaps be explained as the subsoil slowing down the movement of water thus producing lower infiltration rates. However, a possible explanation for the instances where reported field rates are greater than infiltration rates in the laboratory experimentation may be due to leakage around the edge of the core.

Table 2 – Core Pervious Concrete Infiltration Rate Data

Site #	Core#	Field Results (in/hr)*	Lab Results (in/hr)*	Core Depth (in)
Site 1	1	--	627 **	5.1
	2	17.8	34.5	5.1
	3	17.7	20.2	5.5
	4	10.5	3.7	6.9
	5	--	4.8	5.8
	6	10.4	3	6.0
Site 2	1	--	1.4	7.1
	2	17.3	5.6	7.0
	3	10.6	7.1	7.1
Site 3	1	--	2.3	6.0
	2	--	19.7	6.1
	3	--	24	5.9
Site 4	1	--	0	5.6
	2	--	4.4	5.0
	3	0.17	1.3	6.1
	4	0.29	4.8	8.9
	5	--	1	5.9
	6	1.8	5.2	8.1
Site 5	1	--	4.3	7.6
	2	--	5.8	7.0
	3	--	1.8	6.8
Site 6	1	--	188	8.4
	2	--	2.3	7.9
	3	--	0	8.5
Site 7	1	--	86.2	6.8
	2	--	3.2	7.5
	3	--	84.7	8.9
Site 8	1	--	30.8	6.1
	2	--	11	5.8
	3	--	187	6.3

-- Denotes sites where field data are not available

\* Field rates at 3 inch head, laboratory at 9 inch head.

\*\* Site had no indication of traffic flow or deposition.

In addition to single-ring infiltration tests on the concrete cores, one single-ring infiltration test was conducted with the core removed to measure a comparative infiltration rate for the soil. This single-ring infiltrometer field test was conducted on the soil at each of the sites in Florida. Soil samples were collected at each Florida site for lab analysis. Geotechnical analyses were conducted on the soil in the laboratory including sieve analysis and constant-head hydraulic conductivity test. A summary of information pertaining to the soils collected at each site, including results from the geotechnical analyses and the in-situ single-ring infiltrometer field test, are shown in Table 3. Only two of the available field test infiltration rates fall within the range of conductivities obtained from constant-head permeability tests in the laboratory. The remaining field infiltration rates are greater than the hydraulic conductivities predicted from laboratory testing. Discrepancies could be the result of two factors: the infiltration rates determined by the single-ring test do not take into account the head of water used during the test and the soil samples tested in the lab were disturbed samples and may not reflect exactly the same attributes as the soil would in its in situ state.

Visual observations and conversations with individuals with personal knowledge at each site indicated rare occurrence of runoff. Also, frequent vehicle traffic was noted at each site and at the landfill site, routine front-end loader traffic was noted.

Pitt (2002) reported for modified compacted sandy soils similar to that at sites 1-3, a limiting soil infiltration rate of about 5 inches per hour. He used a 4.5 inch head for the test. His result is close to the minimum rate of 5.4 inches per hour reported within this work. Soil compaction and site variability are believed to control the rate more than the small (3-9 inch) head difference between the field and the laboratory testing.

Table 3 – Soils Infiltration Data

Site #	Soil Type (Sieve Analysis)	Field Results (in/hr)	Hydraulic Conductivity Lab (in/hr)
Site 1	Fine Sand	14.8, 34.5	17 – 21
Site 2	Fine Sand with Silt	5.4	11.3 – 24
Site 3	Fine Sand	21.5	3.4 - 7.9
Site 4	Well Graded Sand Over Clay	15.6	10.85, 0.009**
Site 5	Fine Sand	8.8	1.9 - 7.3
Site 6	Gravel Reservoir Clay*	--	--
Site 7	Gravel Reservoir Clay*	--	--
Site 8	Gravel Reservoir Clay*	--	--

\* Field observation only. No lab results taken.

\*\* Clay conductivity rate

-- No data available

Table 4: Laboratory Concrete Compared to Field Concrete and Soil Infiltration Rates

Test Location	Laboratory Concrete Limiting Infiltration Rate Data (in/hr)	Field Derived Concrete Average Limiting Infiltration Rate (in/hr)	Field Soil Rate (in/hr)
Site 1 – Area 1	20.2, 34.5, 627	17.8	34.5
Site 1 – Area 2	3.0, 3.7, 4.8	10.5	14.8
Site 2	1.4, 5.6, 7.1	14.0	5.4
Site 3	2.3, 19.7, 24	--	21.5
Site 4 – Area 1	0, 4.4	0.17	15.6
Site 4 – Area 2	1.0, 4.8, 5.2	1.05	15.6
Site 5	1.8, 4.3, 5.8	--	8.8
Site 6	0, 2.3, 188	--	--
Site 7	3.2, 84.7, 86.2	--	--
Site 8	10.3, 30.8, 187	--	--

The average concrete infiltration rates with average soil infiltration rates are compared in Table 4 for the respective sites visited. Presented are the range of and average concrete infiltration rates for each site as they were measured using the laboratory infiltration test. Average soil rate is based upon the single-ring infiltrometer test conducted on the soil. Soil rates could not be obtained for the non-Florida locations because each site was constructed with a gravel reservoir layer that prevented application of the single-ring infiltration test or the collection of soil samples.

From Table 4 most of the infiltration rates indicate that at the sandy soil sites the concrete rate is generally the control factor for the overall rate at which the system infiltrates stormwater. However, the concrete and soil infiltration rates at sites 1-3 are all greater than 1.4 inch per hour which is sufficient to capture a large percentage of rain (80% or more) over the course of a year (see Figure 8,  $F_{aq} = 0.16$  in/hr).

## **5.2 Mass balance**

### *5.2.1 Simulation*

Table 5 summarizes the input values and results for an annual mass balance simulation. From the table, it is clear that the mass balance predicts that the majority of the parking lots perform with excellent efficiency, even after years of operation. The one exception, Site 4, performed poorly for a number of reasons. The most significant of which is poor construction techniques. Improper mix design and poor placement techniques created a pervious concrete with low infiltrative ability, clogging notwithstanding. Realistically, the porosity shown at Site 4 should probably be less than 0.2 because of poor mix quality. However, porosity tests were not conducted on the cylinders, so an average value was used for all cases.

Additionally, Site 4 was built on top of clayey subsoil with about one foot or less of sand reservoir beneath the concrete. The shallow reservoir constructed over such a low permeability stratum provided some storage for infiltrate. All of the other Florida sites were constructed on top of a natural fine sand material without any reservoir.

Manipulation of the model through various simulations provided important insight into the operation of the system. The two most sensitive factors for % of yearly retention and runoff on an annual basis are the conductivity rates for the concrete and for the water table (aquifer) decline. The rate for concrete ( $F_{conc}$ ) limits the rate at which water enters the system and produces an initial amount of runoff based upon the difference between the rate of rainfall and the limiting rate of infiltration through the concrete. The water table rate ( $F_{aq}$ ) can influence runoff in addition to that caused by impeding the movement of water through the system, thereby reducing the amount of available storage between rain events within the concrete and the subsoil. Sensitivity results are shown in Figure 8.

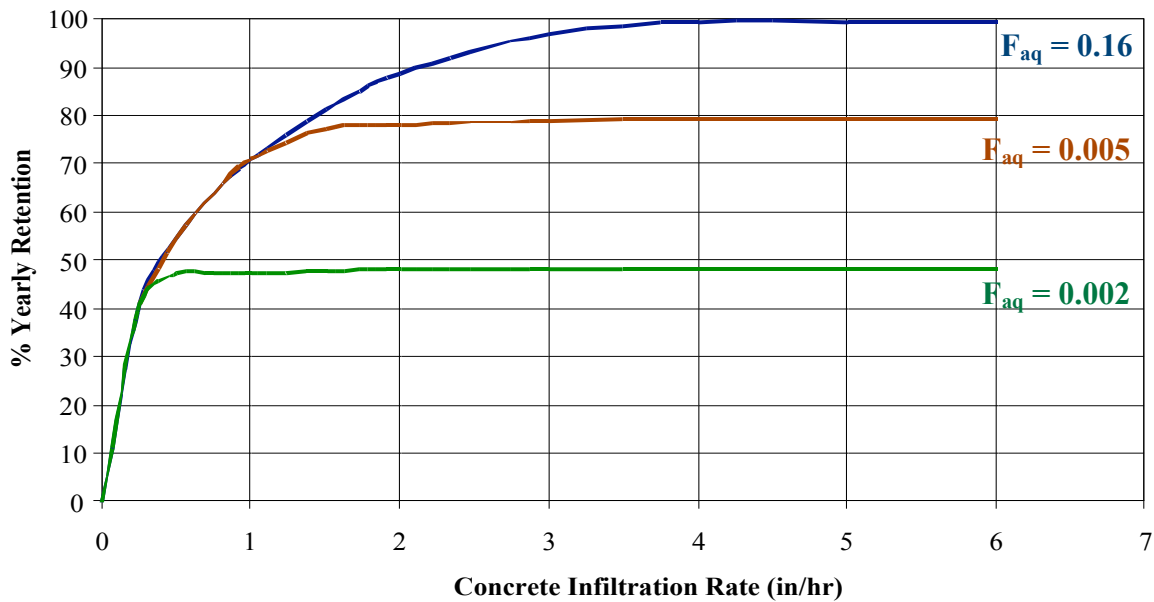

Figure 8 –  $F_{aq}$  Sensitivity for Yearly Volume Retention

Table 5 - Mass Balance Results

LOCATION	INPUT							RESULTS			
	F <sub>conc</sub> * (in/hr)	F <sub>soil</sub> * (in/hr)	F <sub>aq</sub> (in/hr)	D <sub>c</sub> (in)	N <sub>c</sub> (-)	D <sub>wt</sub> (in)	N <sub>s</sub> (-)	Runoff (in)	Recharge (in)	Retained** (%)	
Site 1 - Area 1	227.2	34.5	0.16	5.3	0.2	120	0.35	0	52.49	100%	
Site 1 - Area 2	3.8	14.8	0.16	6.2	0.2	120	0.35	0.27	52.22	99.5%	
Site 2	4.7	5.4	0.16	7	0.2	120	0.35	0.24	52.25	99.5%	
Site 3	15.3	21.5	0.16	6	0.2	72	0.35	0	52.49	100%	
Site 4 - Area 1	1.9	15.6	0.002	5.6	0.2	12	0.35	31.84	20.65	39.3%	
Site 4 - Area 2	3.7	15.6	0.002	7.6	0.2	12	0.35	31.49	21	40.0%	
Site 5	4	8.8	0.16	7.1	0.2	72	0.35	0.27	52.22	99.5%	
Site 8	72.3	5.4	0.16	6	0.2	72	0.35	0	52.49	100%	

\*Average Values

\*\* % Retained = % Infiltrated

### 5.2.2 Yearly Retention

The spreadsheet calculation matrix was developed to simulate the hydrologic performance (retention) of pervious concrete. Using a range of pervious concrete infiltration rates and one year of precipitation data from central Florida, nearly 100 percent infiltration can be expected for a limiting pervious concrete infiltration rate for 3.5 inches per hour. This retention assumes a sandy soil with a soil infiltration rate of 5.4 in/hr (Figure 9).

A stormwater management credit of 80 percent (yearly infiltration volume) can be applied to pervious concrete areas using central Florida rainfall provided the site data are as listed in Figure 9, and so long as the limiting pervious concrete infiltration rate exceeds 1.5 inches per hour. A similar efficiency graph results when the soil infiltration rate ( $F_{\text{soil}}$ ) is as low as 1.0 inches per hour, and a depth to water table of only 12 inches.

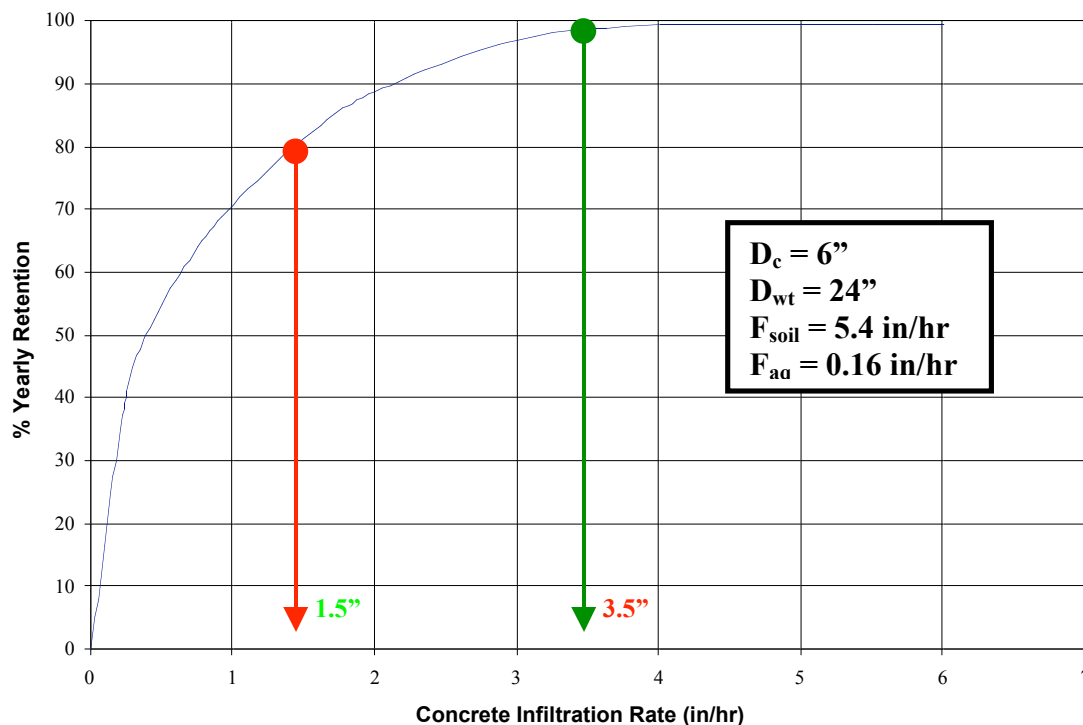

Figure 9 - Percent Yearly Volume Retention as a Function of Concrete Infiltration Rate



## CHAPTER 6 – CONCLUSION AND RECOMMENDATIONS

Data collected and presented over the course of this study provided evidence that pervious concrete retains an infiltrative capacity, provided proper installation, even after years of use. No maintenance was performed at any of the sites. Sites 1, 2, 3 and 5, the four located in Central Florida, had an average of 12.8 years of operation and produced cores with infiltration rates ranging from 1.4 – 627 inches per hour. Excluding the infiltration rate of 627 inches per hour, the average infiltration rate for those sites was 9.87 inches per hour and the median value was 5.2 inches per hour. Considering all of the cores, the laboratory infiltration rates ranged from 0 – 627 inches per hour. It is important to note that the two cores that produced infiltration rates of zero did so as a result of poor installation or a mix that actually clogged pores at the surface.

Excluding the three values greater than 100 and those that were zero, the average infiltration rate for the cores is 8.1 inches per hour and the median value is 4.4 inches per hour. These rates indicate that properly installed pervious concrete can continue to infiltrate even without routine maintenance. For new construction, the infiltration rates of the pervious concrete exceeded that of the parent earth sub-soils, as found at the Stormwater Lab. Thus at first, the limitation to infiltration rate and storage of rain was the sub-soils. After years of operation, however, the system limiting infiltration rate was the pervious concrete in most cases.

### *Recommendation #1*

The single-ring infiltrometer for existing site testing was used. The test was applied for pervious concrete infiltration estimates, while opening of the sub-soil for infiltration

estimates, and facilitating the extraction of 30 pervious concrete cores. Infiltration data collected in the field was not highly correlated with laboratory data produced as evidenced in Table 2. The differences in the infiltration measures could have been caused by leakage in the field seal around the embedded ring or a number of other conditions when samples are extracted from the field site to a laboratory setting. Additionally, the field test of existing concrete is labor intensive and destructive as it requires drilling cores through the pervious concrete in the system being tested. Another limitation of this testing method is that it only functions well when the pervious concrete system is constructed on a sandy soil. The single-ring infiltrometer could not be embedded in the gravel reservoirs on Sites 6 – 8. Also, testing at Site 4 was difficult due to the proximity of the clay layer to the bottom of the concrete in some places. Nevertheless the concept of testing the pervious concrete and the soil as one system proved valuable and lead to the **recommendation that a single ring infiltrometer should be placed in the pervious concrete and about 8 inches into the sub-soil during the construction phase and used for testing infiltration rates in the future.** Embedding the infiltrometer and filling it with concrete will prevent side wall effects that may cause leakage if the ring were embedded after construction.

#### *Recommendation #2*

Mass balance modeling shows that the pervious concrete section of this research can significantly reduce yearly runoff volume based on an average year of precipitation data. A performance of nearly 100 percent retention can be expected with concrete infiltration rates as little as 3.5 inches per hour with sandy conditions found at test sites. **Based on the modeling parameters of a level surface, curbing, and the mix of pervious concrete, it is recommended that the pervious concrete section include a sandy sub base material**

**with at least a two foot depth to the seasonal high water table. When the system infiltration rate is measured by the embedded infiltrometer and the rate is below 1.5 inches per hour, it is recommended that the pervious concrete must be cleaned.**

*Recommendation #3*

Based on the modeling using the data collected, it is **recommended that credit for infiltration of rainwater on pervious concrete systems be given for stormwater treatment.**

## **6.1 Future Research**

The conclusions of this research have provided several aspects that could be further investigated. These relate to the testing methodology and the mass balance simulation.

### *6.1.1 Recommendations for Testing*

To understand and determine yearly volume retention credit for existing pervious concrete with gravel reservoirs for stormwater treatment, it is essential to develop an alternative testing method to address structures that are built with gravel reservoirs. The method of testing existing sites during the course of this study proved unsuccessful with such systems where a gravel reservoir layer was installed. However, when the infiltrometer ring is embedded during construction and penetrates through the gravel and into the soil layer, the field derived infiltration rates can be used in the modeling.

It will be necessary to expand upon the testing method utilized in this study in order to provide a variety of perspectives on the topic. One recommendation is to perform a comparative analysis of infiltration rates using different heads in the single-ring embedded

versus a double ring embedded infiltrometer. Standard depths were used in the testing, such as, three inches for field tests and nine inches for laboratory tests. However, in reality, pervious concrete would rarely experience a water depth of nine inches in parking lots. Most likely it would only endure ponding as great as three inches, and then only during extreme rainfall events. It would be of interest to note how head affects the readings produced from these tests and if it in some way needs to be accounted for in calculations.

Again, it is important to note that the single ring infiltrometer test as used to measure rates at existing sites can also be done by permanently embedded the ring in the concrete during construction. Thus eliminating the effort needed after construction and destruction of the sampling technique. With the addition of an in-situ infiltrometer during the construction phase, a longitudinal study to examine changes in rates over time or with seasonal changes can be done. Specifically, does the pervious concrete experience a greater build up of debris during drier periods and experience a “washing” effect during periods of high precipitation? This could result in a seasonal variation of performance efficiency.

#### *6.1.2 Recommendations for the Mass Balance*

The model can also be used to simulate a flood condition from a single event rainfall event. It is recommended that this single event be used in series with previous rainfall events to determine the storage within the system prior to the flood producing rainfall.

Some model improvements may be helpful to create more realistic simulations. The first of which is to allow for the simulation to consider unsaturated flow within the soil. This would include the movement of wetting in fronts from the initial point of infiltration until contact with the water table. In the current approach, the water moves through the soil

layer at a constant rate and there is no lag time between water entering and exiting the layer or water that moves into a layer is immediately available to leave as outflow. Unsaturated flow conditions would allow for a greater detention time of the infiltrate within the soil layer. This may be important for slow infiltrating sub soils.

Another improvement is to consider a depth of additional surface storage that could be provided should raised curbs be incorporated into the pervious concrete system. This amendment would have to consider the effects of surface storage on the system behavior and would also have to incorporate an additional “mass out” term that would account for weir flow when overtopping of the curb occurred. In conjunction with curbing improvement would be a function for evaluation of the excess rainfall as a function of slope, time, and evaporation. Another recommendation for additions to the model would be an additional sink term for evaporation losses. Accounting for evaporation would yet again refine the simulation to perform more closely to real world operation.

## **APPENDICES: DATA**

**APPENDIX A:**  
**Field Data and Results**

Sun Ray Store-Away, Lake Mary, Florida

Site 1

Core 1 (without Core)

Time (min)	Volume Remaining (mL)	Of (mL)	Volume Added (mL)	Cum Vol Added (mL)
1	0	2000	2000	2000
5	210	3000	2790	4790
7	460	2000	1540	6330
9	0	2000	2000	8330
11	0	2000	2000	10330
13	0	2000	2000	12330
15	0	2000	2000	14330

1000 -670

Diameter 11.63 in  
 Area 106.14 in<sup>2</sup>  
 Vol Rate 1000.00 cm<sup>3</sup>/min  
 61.02 in<sup>3</sup>/min

**Infiltration Rate: 34.50 in/hr**

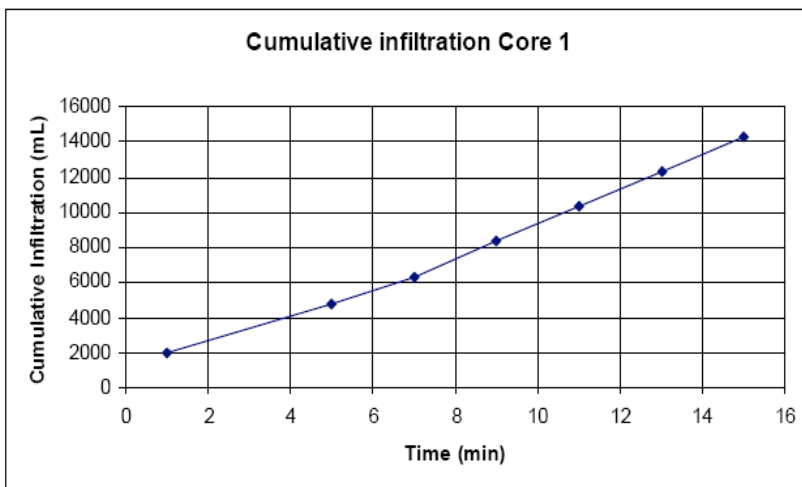



Site 1

Core 2 (with Concrete Core)

Time (min)	Volume Remaining (mL)	Of (mL)	Volume Added (mL)	Cum Vol Added (mL)
1	270	2000	1730	1730
5	460	2000	1540	3270
7	570	2000	1430	4700
9	0	1000	1000	5700
11	0	1000	1000	6700
13	0	1000	1000	7700
15	0	1150	1150	8850

515 1065

Diameter 11.63 in  
 Area 106.14 in<sup>2</sup>  
 Vol Rate 515.00 cm<sup>3</sup>/min  
 31.43 in<sup>3</sup>/min

**Infiltration Rate: 17.77 in/hr**

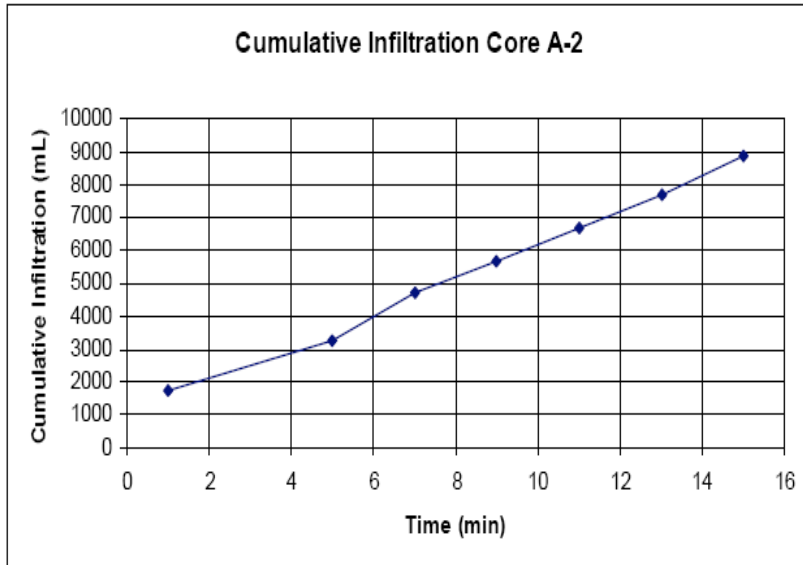

Site 1

Core 3 (with Concrete Core)

Time (min)	Volume Remaining (mL)	Of (mL)	Volume Added (mL)	Cum Vol Added (mL)
1	370	1000	630	630
3	10	1000	990	1620
5	20	1000	980	2600
7	0	1000	1000	3600
9	0	1000	1000	4600
11	785	2000	1215	5815
13	0	1000	1000	6815
15	10	1000	990	7805
20	380	3000	2620	10425
25	550	3000	2450	12875
30	420	3000	2580	15455

513.702 75.9535

Diameter 11.63 in  
 Area 106.14 in<sup>2</sup>  
 Vol Rate 513.70 cm<sup>3</sup>/min  
 31.35 in<sup>3</sup>/min

<b>Infiltration Rate:</b>	<b>17.72</b>	in/hr
---------------------------	--------------	-------

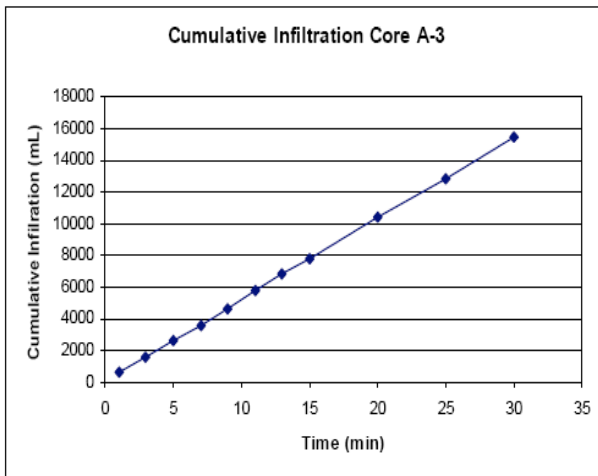

Site 1

Core 4 (with Concrete Core)

304.236 10.10714

Time (min)	Volume Remaining (mL)	Of (mL)	Volume Added (mL)	Cum Vol Added (mL)
1	660	1000	340	340
3	430	1000	570	910
5	220	1000	780	1690
7	550	1000	450	2140
9	440	1000	560	2700
11	430	1000	570	3270
13	380	1000	620	3890
15	340	1000	660	4550
20	470	2000	1530	6080
25	450	2000	1550	7630
30	430	2000	1570	9200

Diameter	11.63	in
Area	106.14	in <sup>2</sup>
Vol Rate	304.24	cm <sup>3</sup> /min
	18.57	in <sup>3</sup> /min

<b>Infiltration Rate:</b>	<b>10.50</b>	in/hr
---------------------------	--------------	-------

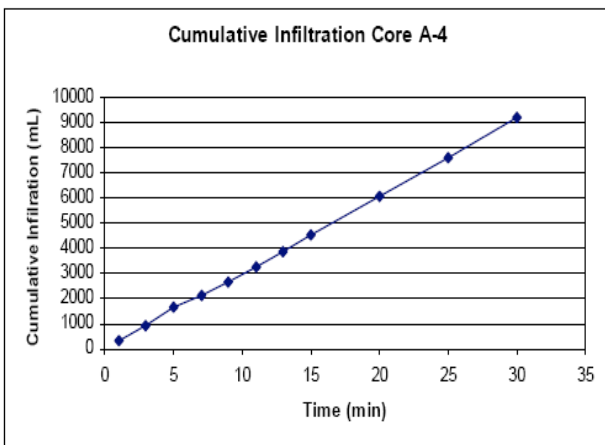

Site 1

Core 5 (without Concrete Core)

427.782 602.5691

Time (min)	Volume Remaining (mL)	Of (mL)	Volume Added (mL)	Cum Vol Added (mL)
1	300	1000	700	700
3	0	1000	1000	1700
5	0	1000	1000	2700
7	20	1000	980	3680
9	30	1000	970	4650
11	170	1000	830	5480
13	100	1000	900	6380
15	180	1000	820	7200
20	0	2000	2000	9200
25	0	2000	2000	11200
30	0	2000	2000	13200

Diameter	11.63	in
Area	106.14	in <sup>2</sup>
Vol Rate	427.78	cm <sup>3</sup> /min
	26.10	in <sup>3</sup> /min

<b>Infiltration Rate:</b>	<b>14.76</b>	<b>in/hr</b>
---------------------------	--------------	--------------

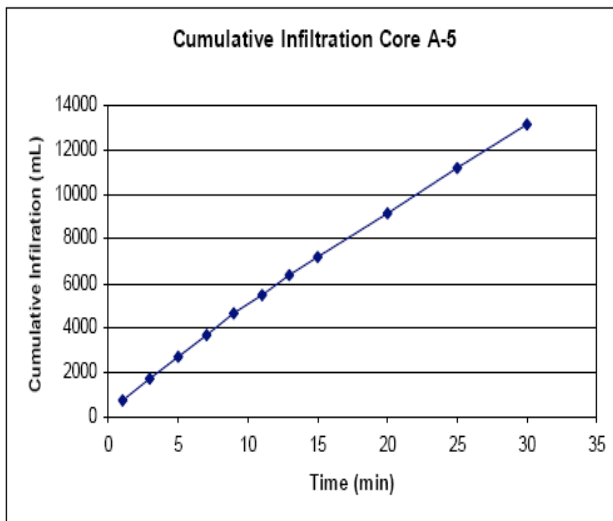

Site 1

Core 6 (with Concrete Core)

301.71 101.1206

Time (min)	Volume		Volume Added (mL)	Cum Vol Added (mL)
	Remaining (mL)	Of (mL)		
1	640	1000	360	360
3	420	1000	580	940
5	370	1000	630	1570
7	260	1000	740	2310
9	390	1000	610	2920
11	560	1000	440	3360
13	320	1000	680	4040
15	390	1000	610	4650
20	500	2000	1500	6150
25	510	2000	1490	7640
30	530	2000	1470	9110

Diameter 11.63 in  
 Area 106.14 in<sup>2</sup>  
 Vol Rate 301.71 cm<sup>3</sup>/min  
 18.41 in<sup>3</sup>/min

<b>Infiltration Rate:</b> 10.41 in/hr
---------------------------------------

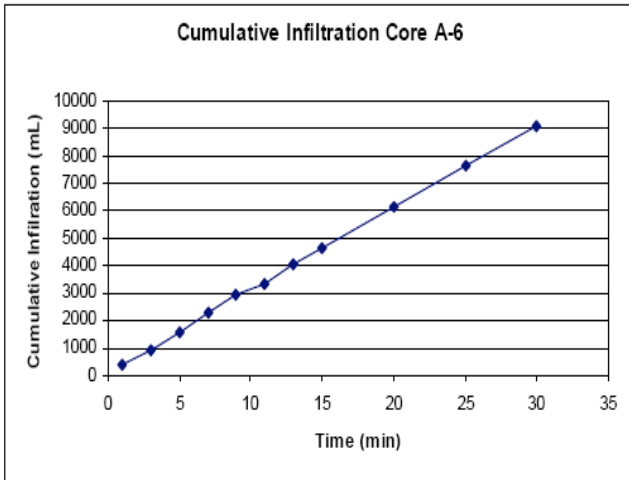

Strange Communications Parking Lot, Lake Mary, Florida

Site 2

Core 1 - Test Run with no Concrete Core

156.8                      986.7

Time (min)	Volume Remaining (mL)	Volume Of (mL)	Volume Added (mL)	Cum Vol Added (mL)
1	680	1000	320	320
2	0	680	680	1000
3	450	1000	550	1550
4	290	450	160	1710
5	940	1000	60	1770
7.5	430	940	510	2280
10	600	1000	400	2680
12.5	330	600	270	2950
15	610	1000	390	3340
17.5	220	610	390	3730
20	620	1000	380	4110
22.5	210	620	410	4520
25	610	1000	390	4910

Diameter 11.63 in  
 Area 106.14 in<sup>2</sup>  
 Vol Rate 156.80 cm<sup>3</sup>/min  
 9.57 in<sup>3</sup>/min

Infiltration Rate: 5.41 in/hr

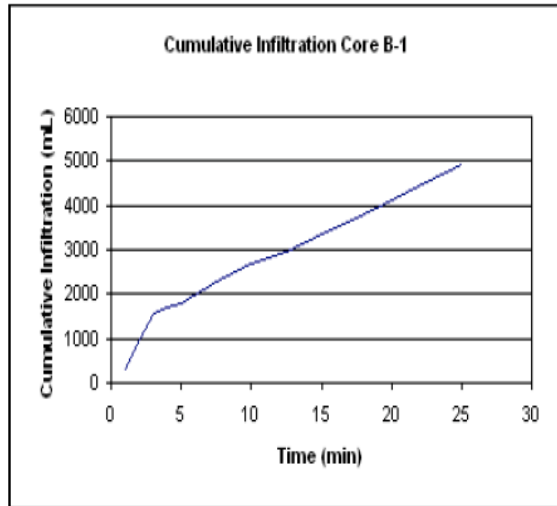

Site 2

Core 2

501.095 -712.678

Time (min)	Volume Remaining (mL)	Of (mL)	Volume Added (mL)	Cum Vol Added (mL)
1	700	1000	300	300
3	700	1200	500	800
5	0	1000	1000	1800
7	0	1000	1000	2800
9	0	1000	1000	3800
11	0	1000	1000	4800
13	0	1000	1000	5800
15	0	1000	1000	6800
20	520	3000	2480	9280
25	490	3000	2510	11790
30	460	3000	2540	14330
35	480	3000	2520	16850

Diameter 11.63 in  
 Area 106.14 in<sup>2</sup>  
 Vol Rate 501.10 cm<sup>3</sup>/min  
 30.58 in<sup>3</sup>/min

**Infiltration Rate: 17.29 in/hr**

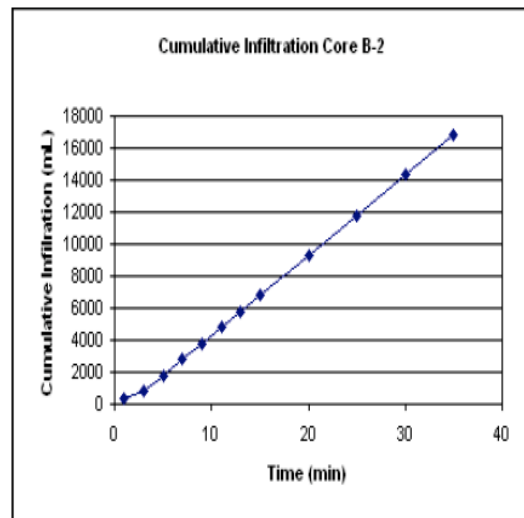

Site 2  
Core 3

307.139 -116.5

Time (min)	Volume Remaining (mL)	Of (mL)	Volume Added (mL)	Cum Vol Added (mL)
1	720	1000	280	280
3	280	1000	720	1000
5	460	1000	540	1540
7	380	1000	620	2160
9	430	1000	570	2730
11	500	1000	500	3230
13	380	1000	620	3850
15	360	1000	640	4490
20	490	2000	1510	6000
25	450	2000	1550	7550
30	320	2000	1680	9230
35	600	2000	1400	10630
40	500	2000	1500	12130
45	450	2000	1550	13680

Diameter 11.63 in  
 Area 106.14 in<sup>2</sup>  
 Vol Rate 307.14 cm<sup>3</sup>/min  
 18.74 in<sup>3</sup>/min

**Infiltration Rate: 10.60 in/hr**

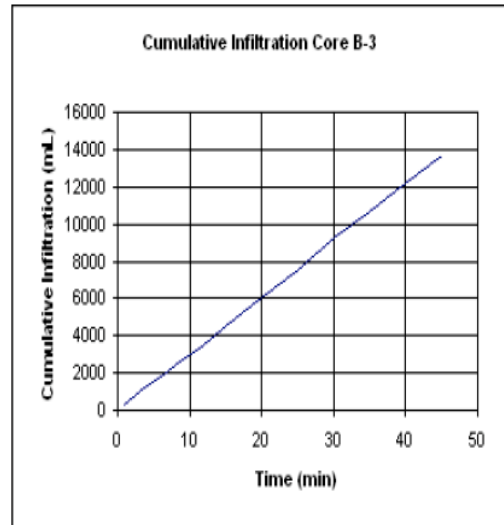



Murphy Vet Clinic Parking Lot, Sanford, Florida

Site 3

Core 2: No Concrete Core

457.5 459.2

Time (min)	Volume Remaining (mL)	Of (mL)	Volume Added (mL)	Cum Vol Added (mL)
1	460	1000	540	540
3	960	2000	1040	1580
5	0	1000	1000	2580
7	100	1000	900	3480
9	10	1000	990	4470
11	100	1000	900	5370
13	50	1000	950	6320
15	0	1000	1000	7320
17	170	1000	830	8150
19	70	1000	930	9080
21	30	1000	970	10050
23	70	1000	930	10980
25	80	1000	920	11900
27	90	1000	910	12810

Diameter 11.63 in  
 Area 106.14 in<sup>2</sup>  
 Vol Rate 457.50 cm<sup>3</sup>/min  
 27.92 in<sup>3</sup>/min

Infiltration Rate: 15.78 in/hr

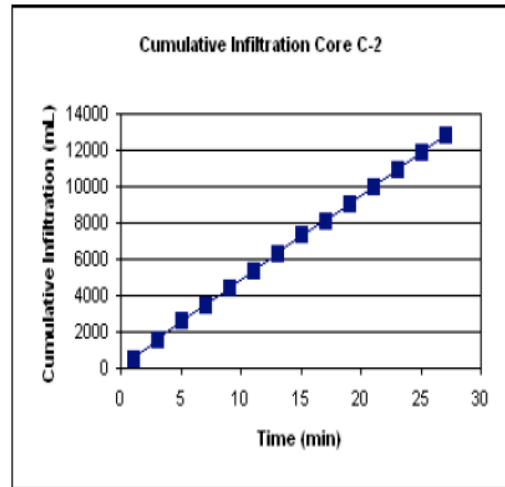

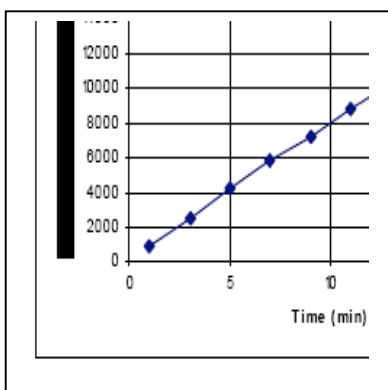

FDEP Office Parking Lot, Tallahassee, Florida

Site 4

Core 1 (without Concrete Core)

Time (min)	Volume Remaining (mL)	Of (mL)	Volume Added (mL)	Cum Vol Added (mL)
1	400	1000	600	600
5	810	2000	1190	1790
7	780	2000	1220	3010
9	0	1000	1000	4010
11	800	2000	1200	5210
13	850	2000	1150	6360
15	830	2000	1170	7530

Diameter 11.63 in  
 Area 106.14 in<sup>2</sup>  
 Vol Rate 580.00 cm<sup>3</sup>/min  
 35.39 in<sup>3</sup>/min

**Infiltration Rate: 20.01 in/hr**

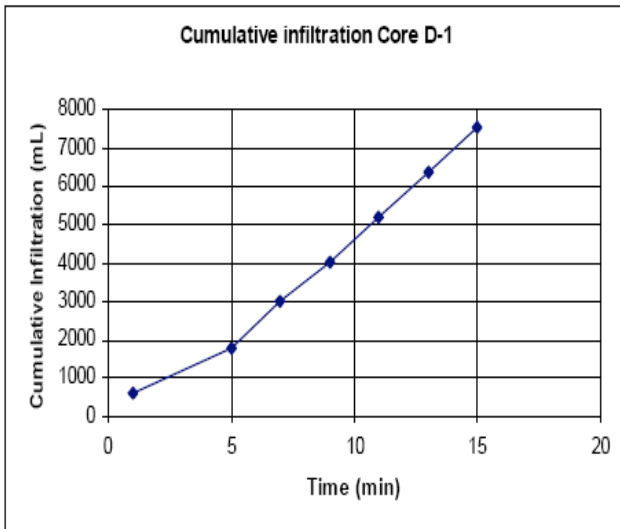

**Site 4**

**Core D-2 (no Concrete Core)**

Time (min)	Volume Remaining (mL)	Volume Of (mL)	Volume Added (mL)	Cum Vol Added (mL)
1	680	1000	320	320
3	300	1000	700	1020
5	300	1000	700	1720
7	370	1000	630	2350
9	380	1000	620	2970
11	350	1000	650	3620
13	320	1000	680	4300
15	360	1000	640	4940

325.5    55.5

Diameter    11.63    in  
 Area        106.14    in<sup>2</sup>  
 Vol Rate    325.50    cm<sup>3</sup>/min  
                  19.86    in<sup>3</sup>/min

**Infiltration Rate: 11.23 in/hr**

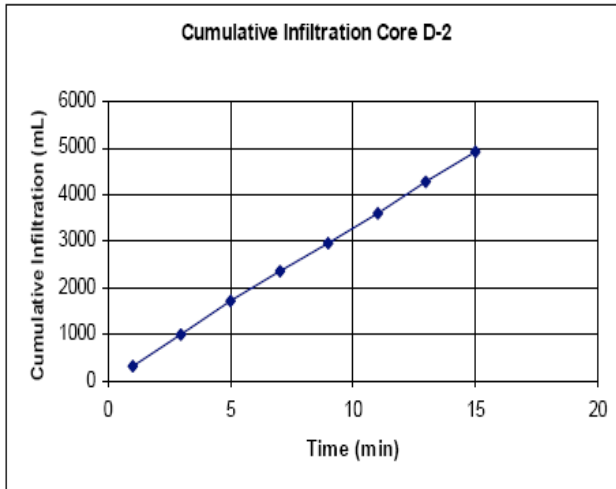

Site 4

Core 2 (with Concrete Core)

Time (min)	Volume		Volume Added (mL)	Cum Vol Added (mL)
	Remaining (mL)	Of (mL)		
1	990	1000	10	10
3	980	1000	20	30
5	975	1000	25	55
7	980	1000	20	75
9	970	1000	30	105
11	990	1000	10	115
13	990	1000	10	125
15	990	1000	10	135

5 0 6

Diameter	11.63	in
Area	106.14	in <sup>2</sup>
Vol Rate	5.00	cm <sup>3</sup> /min
	0.31	in <sup>3</sup> /min

<b>Infiltration Rate:</b>	<b>0.17</b>	<b>in/hr</b>
---------------------------	-------------	--------------

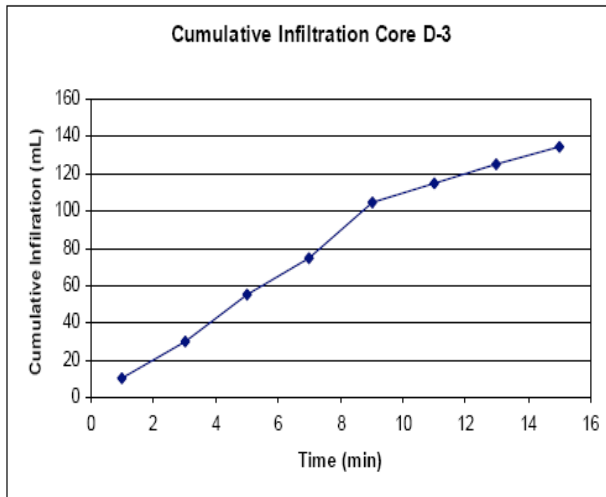

**Site 4**

**Core 4 (with Concrete Core)**

Time (min)	Volume Remaining (mL)	Of (mL)	Volume Added (mL)	Cum Vol Added (mL)
1	960	1000	40	40
3	960	1000	40	80
5	970	1000	30	110
7	980	1000	20	130
9	980	1000	20	150
11	980	1000	20	170
13	990	1000	10	180
15	980	1000	20	200

8.5 72.5

Diameter 11.63 in  
 Area 106.14 in<sup>2</sup>  
 Vol Rate 8.50 cm<sup>3</sup>/min  
 0.52 in<sup>3</sup>/min

**Infiltration Rate: 0.29 in/hr**

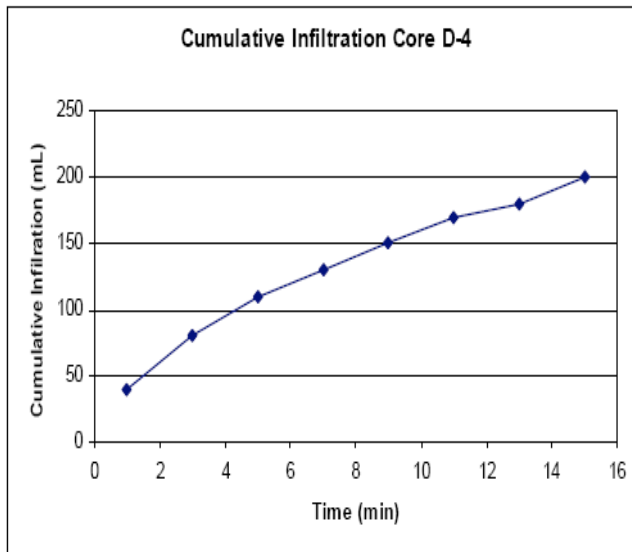

Site 4

Core 5 (without )

Time (min)	Volume Remaining (mL)	Of (mL)	Volume Added (mL)	Cum Vol Added (mL)
1	970	1000	30	30
3	1000	1000	0	30
5	1000	1000	0	30
7	1000	1000	0	30

Diameter	11.63	in
Area	106.14	in <sup>2</sup>
Vol Rate	0.00	cm <sup>3</sup> /min
	0.00	in <sup>3</sup> /min

**Infiltration Rate:** 0.00 in/hr

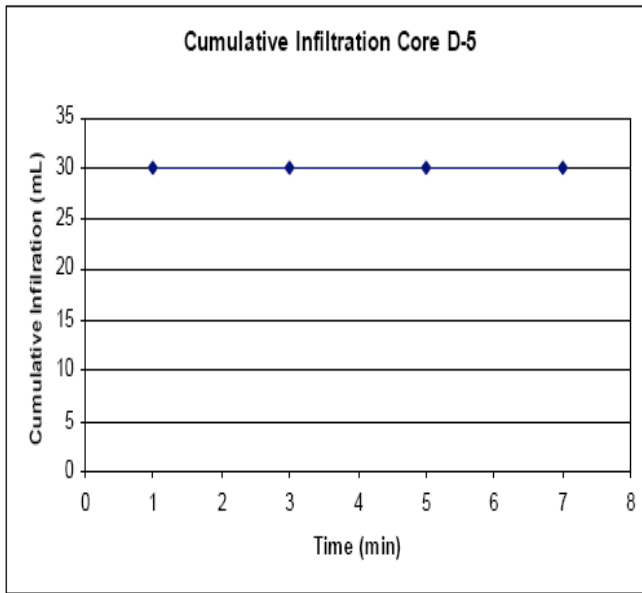

**Site 4**

**Core 6 (with Concrete Core)**

Time (min)	Volume Remaining (mL)	Of (mL)	Volume Added (mL)	Cum Vol Added (mL)
1	870	1000	130	130
3	690	1000	310	440
5	940	1000	60	500
7	880	1000	120	620
9	875	1000	125	745
11	890	1000	110	855
13	910	1000	90	945
15	940	1000	60	1005
20	1000	1000	0	1005
25	1000	1000	0	1005

51.5714 262.619

Diameter 11.63 in  
 Area 106.14 in<sup>2</sup>  
 Vol Rate 51.57 cm<sup>3</sup>/min  
 3.15 in<sup>3</sup>/min

**Infiltration Rate: 1.78 in/hr**

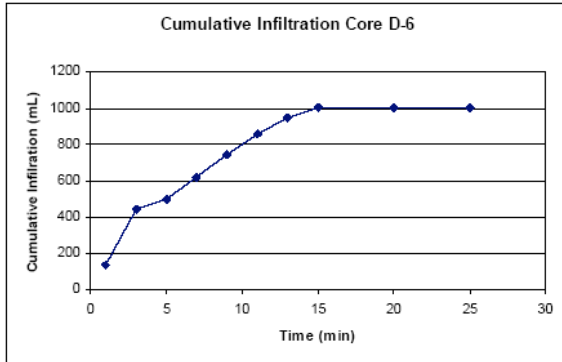



**Site 5**

**Core 1: No Concrete Core**

Time (min)	Volume Remaining (mL)	Of (mL)	Volume Added (mL)	Cum Vol Added (mL)
1	800	1000	200	200
3	370	1000	630	830
5	460	1000	540	1370
7	500	1000	500	1870
9	500	1000	500	2370
11	600	1000	400	2770
13	490	1000	510	3280
15	510	1000	490	3770
17	500	1000	500	4270

Diameter 11.63 in  
 Area 106.14 in<sup>2</sup>  
 Vol Rate 247.50 cm<sup>3</sup>/min  
 15.10 in<sup>3</sup>/min

**Infiltration Rate: 8.54 in/hr**

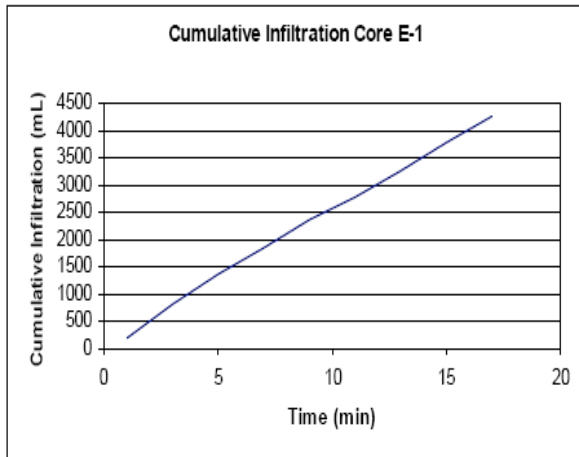

FPCA Office Parking Lot, Orlando, Florida

Site 5

Core 3: No Concrete Core

263 10

Time (min)	Volume Remaining (mL)	Of (mL)	Volume Added (mL)	Cum Vol Added (mL)
1	740	1000	260	260
3	440	1000	560	820
5	500	1000	500	1320
7	465	1000	535	1855
9	475	1000	525	2380
11	490	1000	510	2890
13	460	1000	540	3430
15	470	1000	530	3960

Diameter 11.63 in  
 Area 106.14 in<sup>2</sup>  
 Vol Rate 263.00 cm<sup>3</sup>/min  
 16.05 in<sup>3</sup>/min

**Infiltration Rate: 9.07 in/hr**

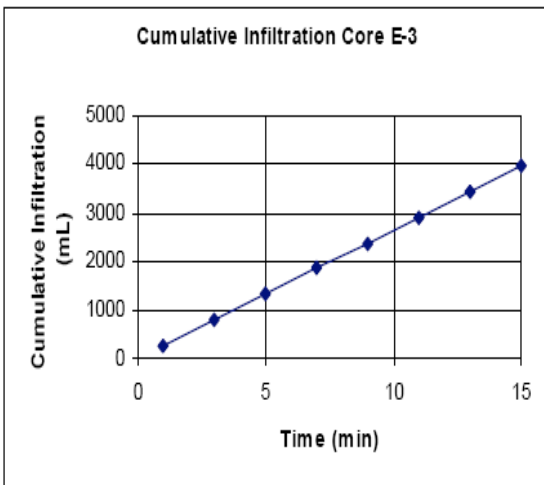

**APPENDIX B:**  
**Laboratory Data and Results**

Area 106.1 in<sup>2</sup>

**Site 1  
Core 1**

Initial  
Amount 10 Liters  
Time 33 Seconds  
  
Rate 303 mL/s  
18182 mL/min  
1110 in<sup>3</sup>/min  
  
Infil Rate 627 in/hr

**Site 1  
Core 2**

Initial Time (min)	Reading (mL)	of (mL)	Volume Added (mL)	Cum Added (mL)		
1	590	2000	1410	1410	Average	
2	0	2000	2000	3410	1000	mL/min
4	0	2000	2000	5410	61	in <sup>3</sup> /min
6	0	2000	2000	7410		
8	0	2000	2000	9410	Infil. Rate	34.5 in/hr

**Site 1  
Core 3**

Initial Time (min)	Reading (mL)	of (mL)	Volume Added (mL)	Cum Added (mL)		
1	200	1000	800	800	Average	
3	360	2000	1640	2440	586	mL/min
5	560	2000	1440	3880	36	in <sup>3</sup> /min
7	610	2000	1390	5270		
9	480	2000	1520	6790	Infil. Rate	20.2 in/hr
11	900	2000	1100	7890		
13	750	2000	1250	9140		
15	800	2000	1200	10340		
17	860	2000	1140	11480		

**Site 1  
Core 4**

Initial

Time (min)	Reading (mL)	of (mL)	Volume Added (mL)	Cum Added (mL)			
1	955	1000	45	45	Average		
3	915	1000	85	130	107.5	mL/min	
5	860	1000	140	270	7	in <sup>3</sup> /min	
7	900	1000	100	370			
9	920	1000	80	450	Infil. Rate	3.7	in/hr
11	890	1000	110	560			

**Site 1  
Core 5**

Initial

Time (min)	Reading (mL)	of (mL)	Volume Added (mL)	Cum Added (mL)			
1	900	1000	100	100	Average		
3	710	1000	290	390	138	mL/min	
5	700	1000	300	690	8	in <sup>3</sup> /min	
7	750	1000	250	940			
9	730	1000	270	1210	Infil. Rate	4.8	in/hr
11	730	1000	270	1480			

**Site 1  
Core 6**

Initial

Time (min)	Reading (mL)	of (mL)	Volume Added (mL)	Cum Added (mL)			
1	980	1000	20	20	Average		
3	825	1000	175	195	86.25	mL/min	
5	825	1000	175	370	5	in <sup>3</sup> /min	
7	810	1000	190	560			
9	850	1000	150	710	Infil. Rate	3.0	in/hr

**Site 2  
Core 1**

Initial

Time (min)	Reading (mL)	of (mL)	Volume Added (mL)	Cum Added (mL)			
1	1000	1000	0	0			
3	870	1000	130	130	Average		
5	1000	1000	0	130	40	mL/min	
7	910	1000	90	220	2	in <sup>3</sup> /min	
9	1000	1000	0	220			
11	930	1000	70	290	Infil. Rate	1.4	in/hr
13	910	1000	90	380			
15	920	1000	80	460			

**Site 2  
Core 2**

Initial

Time (min)	Reading (mL)	of (mL)	Volume Added (mL)	Cum Added (mL)			
1	760	1000	240	240			
3	350	1000	650	890	Average		
5	600	1000	400	1290	163	mL/min	
7	840	1000	160	1450	10	in <sup>3</sup> /min	
9	730	1000	270	1720			
11	670	1000	330	2050	Infil. Rate	5.6	in/hr
13	710	1000	290	2340			
15	790	1000	210	2550			
17	700	1000	300	2850			

**Site 1  
Core 3**

Initial

Time (min)	Reading (mL)	of (mL)	Volume Added (mL)	Cum Added (mL)			
1	790	1000	210	210			
3	610	1000	390	600	Average		
5	580	1000	420	1020	205	mL/min	
7	570	1000	430	1450	13	in <sup>3</sup> /min	
9	590	1000	410	1860			
11	600	1000	400	2260	Infil. Rate	7.1	in/hr

**Site 3****Core 1**

Initial

Time (min)	Reading (mL)	of (mL)	Volume Added (mL)	Cum Added (mL)			
1	890	1000	110	110			
3	870	1000	130	240	Average		
5	750	870	120	360	66	mL/min	
7	850	1000	150	510	4	in <sup>3</sup> /min	
9	720	850	130	640			
11	870	1000	130	770	Infil. Rate	2.3	in/hr

**Site 3****Core 2**

Initial

Time (min)	Reading (mL)	of (mL)	Volume Added (mL)	Cum Added (mL)			
1	50	1000	950	950			
3	400	2000	1600	2550	Average		
5	450	2000	1550	4100	570	mL/min	
7	860	2000	1140	5240	35	in <sup>3</sup> /min	
9	700	2000	1300	6540			
11	860	2000	1140	7680	Infil. Rate	19.7	in/hr
13	870	2000	1130	8810			
15	850	2000	1150	9960			

**Site 3****Core 3**

Initial

Time (min)	Reading (mL)	of (mL)	Volume Added (mL)	Cum Added (mL)			
1	100	1000	900	900			
3	480	2000	1520	2420	Average		
5	600	2000	1400	3820	695	mL/min	
7	600	2000	1400	5220	42	in <sup>3</sup> /min	
9	630	2000	1370	6590			
11	610	2000	1390	7980	Infil. Rate	24.0	in/hr

**Site 4****Core 1**

Initial

Time (min)	Reading (mL)	of (mL)	Volume Added (mL)	Cum Added (mL)	Average		
1	1000	1000	0	0	0	mL/min	
3	1000	1000	0	0	0	in <sup>3</sup> /min	
5	1000	1000	0	0			
					Infil. Rate	0.0	in/hr

**Site 4****Core 2**

Initial

Time (min)	Reading (mL)	of (mL)	Volume Added (mL)	Cum Added (mL)	Average		
1	970	1000	30	30			
3	830	1000	170	200			
5	730	1000	270	470	129	mL/min	
7	740	1000	260	730	8	in <sup>3</sup> /min	
9	750	1000	250	980			
11	750	1000	250	1230			
					Infil. Rate	4.4	in/hr

**Site 4****Core 3**

Initial

Time (min)	Reading (mL)	of (mL)	Volume Added (mL)	Cum Added (mL)	Average		
1	980	1000	20	20			
3	960	1000	40	60			
5	938	1000	62	122	38	mL/min	
7	890	1000	110	232	2	in <sup>3</sup> /min	
9	860	1000	140	372			
11	930	1000	70	442			
13	920	1000	80	522			
					Infil. Rate	1.3	in/hr



**Site 4  
Core 4**

Initial

Time (min)	Reading (mL)	of (mL)	Volume Added (mL)	Cum Added (mL)			
1	915	1000	85	85			
3	710	1000	290	375	Average		
5	790	1000	210	585	139	mL/min	
7.5	690	1000	310	895	8	in <sup>3</sup> /min	
10	660	1000	340	1235			
12.5	750	1000	250	1485	Infil. Rate	4.8	in/hr

**Site 4  
Core 5**

Initial

Time (min)	Reading (mL)	of (mL)	Volume Added (mL)	Cum Added (mL)			
1	1000	1000	0	0			
3	940	1000	60	60	Average		
5	920	1000	80	140	28	mL/min	
7	940	1000	60	200	2	in <sup>3</sup> /min	
9	940	1000	60	260			
11	950	1000	50	310	Infil. Rate	1.0	in/hr

**Site 4  
Core 6**

Initial

Time (min)	Reading (mL)	of (mL)	Volume Added (mL)	Cum Added (mL)			
1	580	1000	420	420			
3	220	1000	780	1200	Average		
5	500	1000	500	1700	152	mL/min	
7	675	1000	325	2025	9	in <sup>3</sup> /min	
9	740	1000	260	2285			
11	700	1000	300	2585	Infil. Rate	5.2	in/hr
13	660	1000	340	2925			
15	710	1000	290	3215			
17	470	710	240	3455			

**Site 5  
Core 1**

Initial

Time (min)	Reading (mL)	of (mL)	Volume Added (mL)	Cum Added (mL)			
1	860	1000	140	140			
3	700	1000	300	440	Average		
5	750	1000	250	690	125	mL/min	
7	740	1000	260	950	8	in <sup>3</sup> /min	
9	760	1000	240	1190			
11	750	1000	250	1440	Infil. Rate	4.3	in/hr

**Site 5  
Core 2**

Initial

Time (min)	Reading (mL)	of (mL)	Volume Added (mL)	Cum Added (mL)			
1	800	1000	200	200			
3	600	1000	400	600	Average		
5	650	1000	350	950	168	mL/min	
7	700	1000	300	1250	10	in <sup>3</sup> /min	
9	660	1000	340	1590			
11	670	1000	330	1920	Infil. Rate	5.8	in/hr
13	660	1000	340	2260			

**Site 5  
Core 3**

Initial

Time (min)	Reading (mL)	of (mL)	Volume Added (mL)	Cum Added (mL)			
1	0	1000	1000	1000			
3	850	1000	150	1150	Average		
5	880	1000	120	1270	52	mL/min	
7	860	1000	140	1410	3	in <sup>3</sup> /min	
9	900	1000	100	1510			
11	900	1000	100	1610	Infil. Rate	1.8	in/hr
13	890	1000	110	1720			

**Site 6**  
**Core 1**  
Initial

2.33 mins for 8 inches of water to drain through

Vol water	849.1	in <sup>3</sup>
Rate	3.1	in/min
	188	in/hr

**Site 6**  
**Core 1**  
Initial

Time (min)	Reading (mL)	of (mL)	Volume Added (mL)	Volume/min (mL/min)	Cum Added (mL)			
2	780	1000	220	110	220			
5	600	1000	400	133	400	Average		
6	850	1000	150	150	150	68	mL/min	
8	770	1000	230	115	230	4	in <sup>3</sup> /min	
10	740	1000	260	130	260			
12	880	1000	120	60	120	Infil. Rate	2.3	in/hr
14	850	1000	150	75	150			
16	820	1000	180	90	180			
18	910	1000	90	45	90			
20	860	1000	140	70	140			
22	830	1000	170	85	170			
24	900	1000	100	50	100			

**Site 6**  
**Core 3**  
Initial

Infil Rate	0	in/hr
------------	---	-------

**Site 7  
Core 1**

Initial

Time (min)	Reading (mL)	of (mL)	Volume Added (mL)	Cum Added (mL)	Average	
					2500	mL/min
2	0	5000	5000	5000	153	in <sup>3</sup> /min
4	0	4000	4000	9000		
6	0	6000	6000	15000	Infil. Rate	86.2 in/hr
8	0	5000	5000	20000		
10	0	5000	5000	25000		

**Site 7  
Core 2**

Initial

Time (min)	Reading (mL)	of (mL)	Volume Added (mL)	Cum Added (mL)	Average	
					92	mL/min
2	820	1000	180	180	6	in <sup>3</sup> /min
4	810	1000	190	370		
6	820	1000	180	550	Infil. Rate	3.2 in/hr

**Site 7  
Core 3**

Initial

Time (min)	Reading (mL)	of (mL)	Volume Added (mL)	Cum Added (mL)	Average	
2	440	6000	5560	5560		
4	0	5000	5000	10560	Average	
6	300	5000	4700	15260	2456	mL/min
8	300	5000	4700	19960	150	in <sup>3</sup> /min
10	400	5000	4600	24560		
					Infil. Rate	84.7 in/hr

**Site 1**

**Core 1**

Initial

Time (min)	Reading (mL)	of (mL)	Volume Added (mL)	Cum Added (mL)	Average		
					894	mL/min	
2	160	2000	1840	1840	55	in <sup>3</sup> /min	
4	130	2000	1870	3710			
6	310	2000	1690	5400	Infil. Rate	30.8	in/hr
8	200	2000	1800	7200			
10	260	2000	1740	8940			

**Site 1**

**Core 2**

Initial

Time (min)	Reading (mL)	of (mL)	Volume Added (mL)	Cum Added (mL)	Average		
					318	mL/min	
2	320	1000	680	680	19	in <sup>3</sup> /min	
4	380	1000	620	1300			
6	370	1000	630	1930	Infil. Rate	11.0	in/hr
8	390	1000	610	2540			

**Site 1**

**Core 3**

Initial

drained 8" in 2:34 minutes

Vol water	849.1	in <sup>3</sup>
Rate	3.1	in/min
	187	in/hr

## LIST OF REFERENCES

- Akan, Osman A., "Sizing Stormwater Infiltration Structures," *Journal of Hydraulic Engineering*, Vol. 128, Issue 5, Pages 534-537, May 2002.
- American Concrete Institute (ACI) Committee 522, "Pervious Concrete", ACI 522R-06, 2006.
- ASTM D 3385-94, Standard Test Method for Infiltration Rate of Soils Using Double-Ring Infiltrometer. American Society for Testing and Materials. 2002. Conshohocken, PA.
- Bean, E.Z.; Hunt, W. F.; Bidelspach, D. A., "Study on the Surface Infiltration of Permeable Pavements." May 2004.
- Brattebo, Benjamin B., and Derek B. Booth, "Long-Term Stormwater Quantity and Quality Performance of Permeable Pavement Systems," *Water Research*, Vol. 37, Issue 18, 2003, pp 4369-4376.
- Brown, Dan, P.E., "Pervious Concrete Pavement: A Win-Win System," *Concrete Technology Today*, Vol. 24, No. 2, Portland Cement Association, August 2003.
- Charbeneau, Randall J. *Groundwater Hydrology and Pollutant Transport*. Page 8. Upper Saddle, New Jersey: Prentice Hall, 2000.
- Ferguson, Bruce K. *Porous Pavements*. Page 418 - 421. Boca Raton, Florida: CRC Press, 2005.
- Fischer, David, Charles, E. G., Baehr, A. L. "Effects of Stormwater Infiltration on Quality of Groundwater Beneath Retention and Detention Ponds," *Journal of Environmental Engineering*, Vol. 129, Issue 5, Pages 464-471, May 2003.

Florida Concrete and Products Association, "Pervious Pavement Manual," Orlando Florida, Latest version, 2006.

[http://www.cityoforlando.net/public\\_works/stormwater/rain/rainfall.htm](http://www.cityoforlando.net/public_works/stormwater/rain/rainfall.htm). Referenced June 12, 2006.

Legret, M.; Colandini, V.; and Le Marc, C., "Effects of a porous pavement with reservoir structure on the quality of runoff water and soil." *The Science of the Total Environment* 189/190, Pages 335-340, 1996.

Minton, Gary, *Stormwater Treatment*, pp 231-238. Seattle, Washington: Amica International Inc. 2002.

National Ready Mixed Concrete Association, "Concrete in Practice, CIP 38- Pervious Concrete, 2004.

Pitt, R., S. Chen and S. Clark. "Compacted Urban soil Effects on Infiltration and Bioretention Stormwater Control Designs", 9<sup>th</sup> International Conference on Urban Drainage, 2002.

Schluter, Wolfram and Jeffries, C., "Modeling the Outflow from a porous pavement," *Urban Water*, Vol. 4, Issue 3, September 2002.

St. John's River Water Management District, *Management and Storages of Surface Waters (MSSW) Handbook*, Chapters 40C-41 and 40C-42, Revised November 2003.

Training Manual, TM/ERP -980521.a. Southwest Florida Water Management District. 1998.

United States Environmental Protection Agency, Office of Water. *Storm Water Technology Fact Sheet: Porous Pavement*. EPA 832-F-99-023, Washington D.C., 1999.

Wanielista, M.P., Yousef, Y.A., Harper, G.M., Lineback, T.R., and Dansereau, L.D., "Precipitation, Inter-Event Dry Periods, and Reuse Design Curves for Selected Areas of Florida", Florida Department of Environmental Protection, November, 1991.

Wanielista, M.; Kersten, R; Eaglin, R., *Hydrology: Water Quantity and Quality Control*.

Pages 7, 8, 314-315. John Wiley & Sons, 1997.

Yang, Jing and Guoliang Jian, “Experimental Study on Properties of Pervious Concrete

Pavement Materials,” *Cement and Concrete Research*, v. 33, Issue 3: pg381, March

2003.





© 2007